



**Geethanjali College of Engineering and Technology**  
**(UGC Autonomous)**

CHEERYAL (V), KEESARA (M) - 501301, Telangana

Date: May 9<sup>th</sup>, 2017

To  
The Principal  
Geethanjali College of Engineering and Technology  
Cheeryal  
Telangana - 501301.

Respected Sir,

Sub: Attending the Workshop on UAV - Regarding

We would like to attend a workshop being conducted by Skyfi Labs, in Hyderabad starting May 22<sup>nd</sup> till May 27<sup>th</sup>, 2017. The cost for the same will be Rs 3490/- per person. We will be thankful if this amount can be reimbursed by the college.

We request you to please consider the time we are attending the workshop as On-duty. We do not have any impact on the classes as the final exams are in progress and there is no class work.

Thanking you,

  
Prof. N. Chandrakanth  
CSE, GCET

  
Mr. Y.V. N. Phani Kishore  
CSE, GCET

  
**PRINCIPAL**  
Geethanjali College of Engg. Techn.  
Cheeryal (V), Keesara (M), R.R. Dist: (A.R.) - 501 301.

to Secretary to  
with a request to pay Rs. 2,10  
to each person as it is very



VERIFIED  
CERTIFICATE

**Skyfi**  
labs

LEARN ENGINEERING  
PRACTICALLY!

**AEROTRIX**  
LEARN AEROSPACE PRACTICALLY!  
PRINCIPAL  
Geethanjali College of Engg. Tech.  
Cheeryal (V), Kaesara (M), R.R. Dist. (A.P.) - 501 301

www.aerotrix.com  
www.skyfilabs.com

27 May 2017

Skyfi Labs Center, Abids,  
Hyderabad

This is to certify that

**N.CHANDRAKANTH**

has completed a 6-day project-based training program on

**Quadrotor and RC Aircraft**

Unique Certificate Code: **34360007**

Verify at [www.skyfilabs.com/verify-certificate/34360007](http://www.skyfilabs.com/verify-certificate/34360007)



Pavan Kumar P  
CEO, Skyfi Labs



Date: 6<sup>th</sup> March, 2017.

To  
The Principal,  
Geethanjali College of Engineering and Technology,  
Cheeryal.

Respected Sir,

We are conducting a workshop on "Usage of Raspberry PI" for the students who are part of the Innovation club, on Wednesday 8<sup>th</sup> March, 2017, for the whole day.

Following are the expenses we foresee to be incurred. I request you to please approve the same for smooth conduct of the workshop.

Sl No	Description	Amount (in Rs.)
1	Banner	600
2	Posters	900
3	Certificates	750
4	Tea (300), Juice (1000)	1300
5	Lunch (for organizers and lecturers)	500 X
6	News paper	1250
7	Name plates (6 numbers)	1000 X
	Total	Rs. 6300.00

We also request you to please approve an amount of Rs 3500.00 as advance. We will provide the details of expenditure and submit the bills (where applicable) as soon as the event is complete.

Thanks and Regards



Prof. Chandrakanth N.  
Dept of CSE  
GCET

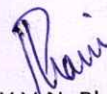

Y.V.N. Phani Kishore  
Asst. Prof.,  
Dept of CSE

*Submitted to Secretary for approval*

*Stg 9/06/08/17*

PRINCIPAL  
Geethanjali College of Engg. Techn.  
Cheeryal (V), Keesara (M), R.R. Dist. (A.P.) - 501 301

*Secretary*

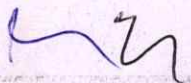

A.Y :2016-17 II- Semester  
Geethanjali College of Engineering and Technology  
Department of Computer Science & Engineering  
SDP on: "Usage of Raspberry Pi" for II Year B.Tech students On 08.03.2017  
RESOURCE PERSON: Mr.Subramanyam,Asst.Prof,GCET

**STUDENT'S FEEDBACK**

(5-Excellent, 4-Very Good, 3-Good, 2-Satisfactory, 1-Unsatisfactory)

Audibility	Explanation	Practical Approach	Understanding Level	Overall Experience
	5	4	5	4

Any Suggestions:

Excellent

**PRINCIPAL**  
Geethanjali College of Engg. Techn.  
Cheeryal (V), Keosara (M), R.R. Dist. (A.P.) - 501 301



A.Y :2016-17 II- Semester  
Geethanjali College of Engineering and Technology  
Department of Computer Science & Engineering  
SDP on: "Usage of Raspberry Pi" for II Year B.Tech students On 08.03.2017  
RESOURCE PERSON: Mr.Subramanyam,Asst.Prof,GCET

**STUDENT'S FEEDBACK**

(5-Excellent, 4-Very Good, 3-Good, 2-Satisfactory, 1-Unsatisfactory)

Audibility	Explanation	Practical Approach	Understanding Level	Overall Experience
4	5	3	4	5

Any Suggestions:

good



Geethanjali College of Engg. Techn.  
Cheerla (V), Keesara (M), R.R. Dist. (A.P.) - 501 301



Geethanjali

Phone 9533791618  
Fax +91-40-24220320  
Website: www.geethanjalinstitutions.com  
info@gcet.edu.in

# Geethanjali College of Engineering and Technology

## AUTONOMOUS

(Accredited by NBA, Approved by AICTE, New Delhi)

Sy.No. 33 & 34, Cheeryal (V), Keesara (M), Medchal District. - 501 301.

Date: 6/4/2017

### Letter of Appreciation

To,

A. Subramanyam, Asst. Prof.,  
Dept of ECE,  
Geethanjali College of Engineering and Technology.

The management of Geethanjali College of Engineering and Technology (GCET) would like to thank you for taking part in the Student Development Program on "Usage of Raspberry PI" to the students enrolled to the Innovation Club which is part of the Incubation Centre at GCET, conducted on 8<sup>th</sup> March 2017.

It is an honour that you are the resource person for the event. We believe that the knowledge you have shared with the students will help them immensely in their future project work and innovation thinking.

*Siva*

PRINCIPAL  
PRINCIPAL

Geethanjali College of Engg. and Tech.  
Cheeryal (V), Keesara (M), Medchal Dist.(T.S.)-501 301.

*Siva*  
PRINCIPAL  
Geethanjali College of Engg. and Tech.  
Cheeryal (V), Keesara (M), R.R. Dist. (A.P.) - 501 301.



# Geethanjali College of Engineering and Technology

CHEERYAL (V), KEESARA (M), R.R.DIST-501301, Telangana

Date: 16/4/2017

To,  
The Principal,  
GCET, Cheeryal.

Respected Sir,

The Workshop on "Usage of Raspberry PI" was conducted successfully to the students of innovation club. The following are the expenses incurred for the above.

Sl. No	Description	Amount
1	Banner printing	Rs 368.00
2	Poster printing	Rs 788.00
3	10" Display clamps	Rs. 750.00
4	Travel charges for transport for Banner (no bill)	Rs. 300.00

Total : Rs 2206.00

Advance Amount: Rs. 3500.00 (Three thousand five hundred only)

Balance (returnable) : Rs.1294.00

I request you to please approve the above.

Thanks and Regards



N. Chandrakanth

Convener

FDP

TO  
A/c  
Sive  
16/04/17

PRINCIPAL  
Geethanjali College of Engineering and Technology  
Cheeryal (V), Keesara (M), R.R. Dist. - 501301



Date: 4/3/2017

To  
The Head of the Department  
Department of ECE  
GCET.

Respected Sir,

We are conducting a workshop on "Usage of Raspberry PI" for the students who are part of the Innovation club. We request you to please allocate E-Class Room 1 (1<sup>st</sup> floor, Block 1) for the same on Wednesday 8<sup>th</sup> March, 2017, for the whole day.

Thanks and Regards

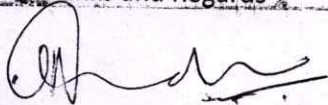

Prof. Chandrakanth N.  
Dept of CSE  
GCET

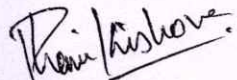

Y.V.N. Phani Kishore  
Asst. Prof.,  
Dept of CSE  
GCET.



PRINCIPAL  
Geethanjali College of Engg. Tech.  
Cheeryal (V), Keesara (M), R.R. Dist. (A.P.) - 501 304



usage of Raspberry pi List of Participants				Date	8/3/2017
S.No	Event	Roll No	Name	Branch	
1	Usage of Raspberry Pi	14R11A04M6	Pranav Raju	ECE	
2		15R11A0482	K.J.C. PAVAN KUMAR	ECE	
3		14R11A04J6	KEERTHI B	ECE	
4		15R11A0485	K V NIKHIL	ECE	
5		15R11A0479	J S V TARUN	ECE	
6		14R11A04J0	ABHIJEETH KUMAR	ECE	
7		15R11A0493	M SRUJANA	ECE	
8		15R11A0472	D.S. JAYA MADHAVI	ECE	
9		15R11A0562	A.S. BRUHADROOP	CSE	
10		15R11A0571	VISHNU HARSHITH	CSE	
11		14R11A0521	K VYSHNAVI	CSE	
12		15R11A05B0	G NAGA LAKSHMI	CSE	
13		15R11A05E7	M RAHUL SAI	CSE	
14		15R11A05A5	P. TANMAYI	CSE	
15		15R11A05A0	P. GREESHMA	CSE	
16		15R11A05K3	D V N RAMYA SAMHITHA	CSE	
17		16R11A0589	T. DEEKSHA	CSE	
18		16R11A05K2	A SRI MOULIKA	CSE	
19		16R11A0524	K SAI PRIYA	CSE	
20		16R11A05E2	V. R. RAHUL	CSE	
21		15R11A0352	T SRIKAR SHARMA	ECE	
22		15R11A0315	D V VARMA	ECE	
23		15R11A0343	P VISHAL VINAY	ECE	
24		15R11A0353	T RAJU	ECE	
25		15R11A0350	M D SHADIK	ECE	
26		15R11A03141	P SANTOSH RAHUL	ECE	
27		15R11A0346	P V S RAKESH	ECE	
28		15R11A0312	TEJHESH	ECE	
29		15R110248	PIYUSH	EEE	

  
**PRINCIPAL**  
 Goethanjali College of Engg. Tech.  
 Cheeryal (V), Keerasa (M), R.R. Dist. (A.P.) - 501 301



CASH / CREDIT BILL

# VENKATARAMANA DIGITAL IMAGING PVT. LTD.

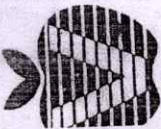

Building Trust Through Service

HEAD OFFICE: # 6-2-969/C, Opp. Sant Nirankari Bhavan, Khairathabad, Hyderabad - 500 004.  
Ph : 040 - 2332 8929 / 49 Cell : 9346 00 8929 / 8949  
AMEERPET BRANCH : # 8-3-949/3, Beside BIG BAZAR, Ameerpet, Hyderabad - 500 073.  
Ph : 040 - 2373 5153 / 7080 Cell : 9346 10 5153 / 7080  
MANAGEMENT CELL : 98480 47896 / 93480 47896.

Bill No.: VDIPL/KPI/ **2820** Date: **7/3/17**

Name: **Rasu**

Address:

Sl. No.	Description	Qty.	Rate	Amount Rs. Ps.
1	De beer freendli			350-00
	UTB: 1004			
	finishing			18-00
	vud@51-			
	T			
				368-00

VAT No.: 36811457366 PAN No.: AADCV2334A SERVICE TAX No.: AADCV2334ASD001 CIN: U22219TG2010PTC067773  
Note: Goods once sold will not be taken back. Interest will be charged @ 24% if this payment is not made on or before due date.  
Subject to Hyderabad Jurisdiction. E.O.E.

Received the above goods in good condition For Venkataramana Digital Imaging Pvt. Ltd.

Customer Signature with Stamp  
*(Signature)*  
Authorised Signatory

CASH / CREDIT BILL

# VENKATARAMANA DIGITAL IMAGING PVT. LTD.

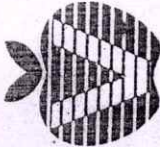

Building Trust Through Service

HEAD OFFICE: # 6-2-969/C, Opp. Sant Nirankari Bhavan, Khairathabad, Hyderabad - 500 004.  
Ph : 040 - 2332 8929 / 49 Cell : 9346 00 8929 / 8949  
AMEERPET BRANCH : # 8-3-949/3, Beside BIG BAZAR, Ameerpet, Hyderabad - 500 073.  
Ph : 040 - 2373 5153 / 7080 Cell : 9346 10 5153 / 7080  
MANAGEMENT CELL : 98480 47896 / 93480 47896.

Bill No.: VDIPL/KPI/ **2556** Date: **9/2/17**

Name: **Rasu**

Address:

Sl. No.	Description	Qty.	Rate	Amount Rs. Ps.
1	12.6x19.2 Calarner			750-00
	finishing			
	vud@51-			38-00
				788-00

VAT No.: 36811457366 PAN No.: AADCV2334A SERVICE TAX No.: AADCV2334ASD001 CIN: U22219TG2010PTC067773  
Note: Goods once sold will not be taken back. Interest will be charged @ 24% if this payment is not made on or before due date.  
Subject to Hyderabad Jurisdiction. E.O.E.

Received the above goods in good condition For Venkataramana Digital Imaging Pvt. Ltd.

Customer Signature with Stamp  
*(Signature)*



8 March 2013

SDI on Usage of Raspberry Pi

Attendance

1.	Pavan Raju A	14R11A04M6	
2	T. Srikar Sharma	15R11A0352	
3	K.J.C. Pawan Kumar	15R11A0488	
4.	Kireeki Bhuvanababu	14R11A04J6	
5.	A.S. Bruhadroop	15R11A0562	
6	V. Shiva Kumar	15R11A05H6	
7.	Piyush	15R11A0248	
8.	K.V. Nikhil	15R11A0485	
9.	Nishnu Harchith	15R11A0571	
10	shreyas	15R11A05B8	
11	I Sai Venkata Tamm	15R11A0477	
12	K. Vaishnavi	14R11A0521	
13	S. Nagalakshmi	15R11A05B0.	
14	M. Lalitha	15R11A05E2	
15	Abhijeet Kumar	14R11A04J0	
16	Ventel Sai	15R11A0244	
17	Bharadwaj	15R11A0314	
18	M. Sujara	15R11A0493	
19	Tanmayi.P	15R11A05A5	

PRINCIPAL  
 Geethanjali College of Engg. Tech.  
 Cheeryal (V), Keerasa (HA), R.R. Dist. (A.P.) - 501306

14 M. Lalitha M. Lalitha  
 15 Abhijeet Kumar L4R11A04J0  
 16 Ventel Sai 15R11A0244  
 17 Bharadwaj 15R11A0314  
 18 M. Sujara 15R11A0493  
 19 Tanmayi.P 15R11A05A5





Geethanjali

Phone : 9533791618  
Fax : +91-40-24220320  
Website : www.geethanjaliinstitutions.com  
info@gcet.edu.in

# Geethanjali College of Engineering and Technology

## AUTONOMOUS

(Accredited by NBA, Approved by AICTE, New Delhi)

Sy.No. 33 & 34, Cheeryal (V), Keesara (M), Medchal District. - 501 301.

PRINCIPAL  
Geethanjali College of Engg. Tech.  
Cheeryal (V), Keesara (M), R.R. Dist. (A.P.) - 501 301

Date: 6/4/2017

### Letter of Appreciation

To,

A. Subramanyam, Asst. Prof.,  
Dept of ECE,  
Geethanjali College of Engineering and Technology.

The management of Geethanjali College of Engineering and Technology (GCET) would like to thank you for taking part in the Student Development Program on "Usage of Raspberry Pi" to the students enrolled to the Innovation Club which is part of the Incubation Centre at GCET, conducted on 8<sup>th</sup> March 2017.

It is an honour that you are the resource person for the event. We believe that the knowledge you have shared with the students will help them immensely in their future project work and innovation thinking.

*Siva*

PRINCIPAL  
PRINCIPAL

Geethanjali College of Engg. and Tech.  
Cheeryal (V), Keesara (M), Medchal Dist.(T.S.)-501 301.



# 'గీతాంజలి' లో ఉత్సాహంగా కార్యశాల

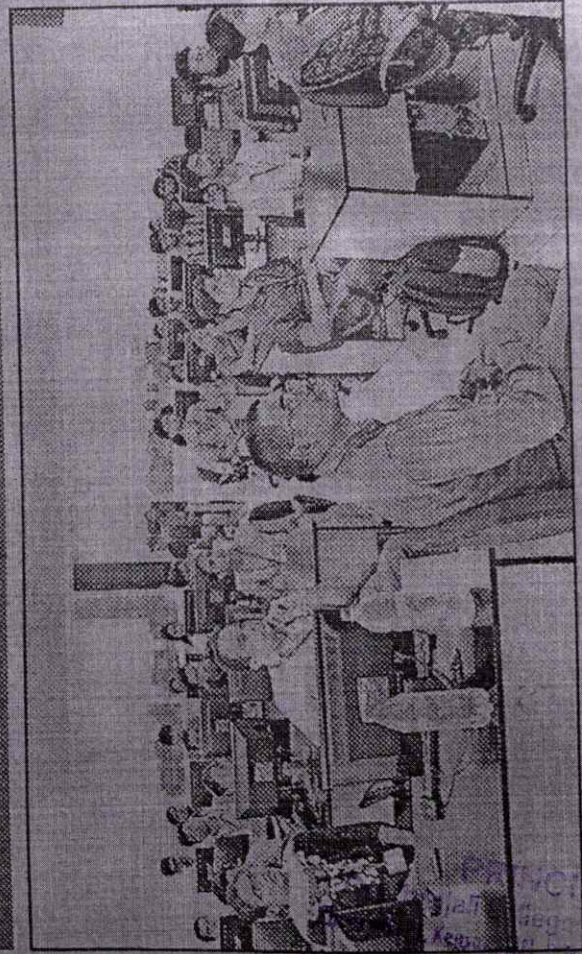

హాజరైన విద్యార్థులు

హైదరాబాద్, న్యూస్టుడె: విద్యార్థులు భవిష్యత్తులో చేపట్టే ఆవిష్కరణలకు కళాశాలల్లో నిర్వహించే కార్యశాలలు ఎంతో ఉపయోగపడతాయని గీతాంజలి ఇంజనీరింగ్ కళాశాల ప్రిన్సిపల్ డా.ఎస్.ఉదయకుమార్ అన్నారు. కీసర మండలం చీర్యాలలోని గీతాంజలి ఇంజనీరింగ్ కళాశాలలో ఇంక్యుబేషన్ సెంటర్ విద్యార్థులచే 'రాస్పబెర్' కార్యశాల జరిగింది. ఇన్నోవేషన్ క్లబ్, స్టూడెంట్ చాప్టర్, సీఎస్ఐ



కార్యశాలలో ఉత్సాహంగా..

సంయుక్త ఆధ్వర్యంలో ప్రొఫెసర్లు చంద్రకాంత్, పణికిశోర్ దీనిని నిర్వహించారు. ఈ సందర్భంగా వారు మాట్లాడుతూ.. తమ కళాశాలలో చేపట్టే కార్యక్రమాలు విద్యార్థులకు ఎంతో ఉపయోగపడతాయన్నారు. డా.ఎస్.నాగేంద్రకుమార్, గుంటూరు విజయ మాట్లాడుతూ.. విద్యార్థులు సాంకేతిక నైపుణ్యాలను పెంచుకోవాలన్నారు. నైపుణ్యాలే భవిష్యత్తును నిర్ణయిస్తాయన్నారు.

ముహూర్తం పొల్లూగం ఆర్ట్స్ క్లబ్ నుండి



PRINCIPAL  
Geethanjali College of Engg. Techn.  
K.R. Dora (A.P.) - 501301  
(M) Keesara



Naveen Stationary Supplies  
Shop No 2-8-1938  
Opp. Lakshmi Narayana Temple  
Boggulkunta, Secunderabad -  
500031

To *Phani*

Estimation

Date *8/3/17*

	Rate	Amount
<i>10" size drilling (10)</i>	<i>75</i>	<i>750</i>
		<i>750</i>

Receiver's Signature

*Phani*

For Naveen Stationary Supplies

*[Signature]*



20	D.V. Varma	15R11A0315	Varma
21	P. Vishal vinay	15R11A0343	P. Vishal Vinay
22	T. Raju	15R11A0353	Raju
23	D.S. JAYAMADHAVI	15R11A0492	Jayamadhavi
24	SADIQ MD	15R11A0350	Sadiq
25	SANTHOSH	15R11A0344	Santhosh
26	G. Anilkumar	15R11A03K8	Anilkumar
27	P.V.S. Rakesh	15R11A0346	Rakesh
28	Thejesh	15R11A0312	Thejesh

PRINCIPAL  
Geethanjali College of Engg. Tech.  
Cheeryal (V), Keesarid (M), R.R. Dist. (AP) - 50

- 29 G. Bharath
- 30 P. Gishma
- 31 D.V.N. Ranjya Samithra
- 32 T. Deeksha
- 33 A. Sri Moulika
- 34 K. Saipriya
- 35 M.R. Rakul

36  
37  
38  
39



PRINCIPAL  
Geethanjali College of Engg. Techn.  
(Cheyral (V), Keerasara (M), R.R. Dist. (A.P.) - 501 301)

Date: 4/3/2017

To  
The Head of the Department  
Department of ECE  
GCET.

Respected Sir,

We are conducting a workshop on "Usage of Raspberry Pi" for the students who are part of the Innovation club. We request you to please allocate E-Class Room 1 (1<sup>st</sup> floor, Block 1) for the same on Wednesday 8<sup>th</sup> March, 2017, for the whole day.

Thanks and Regards

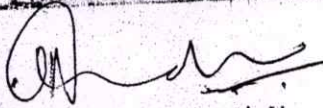

Prof. Chandrakanth N.  
Dept of CSE  
GCET

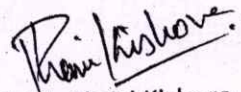

Y.V.N. Phani Kishore  
Asst. Prof.,  
Dept of CSE  
GCET.



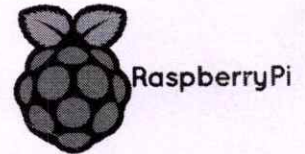

## Raspberry Pi 3 Model B

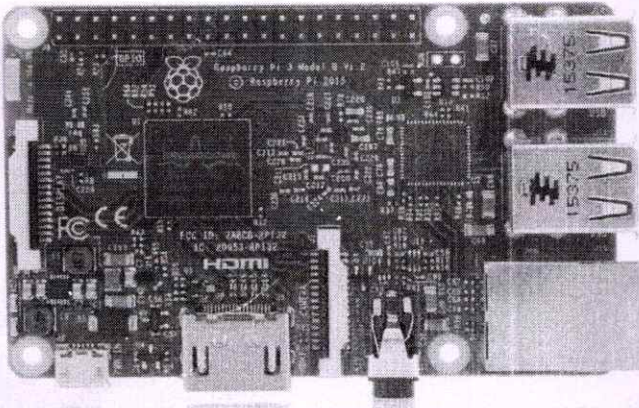

RASPBERRYPI-MODB-1GB

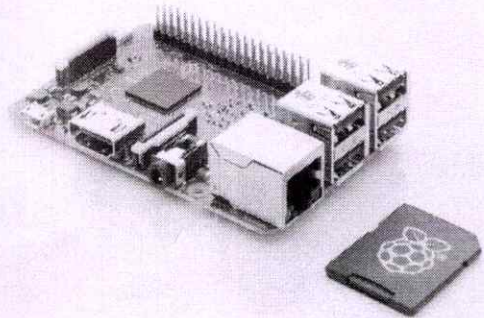

RPI-MODB-16GB-NOOBS

### Technical Specification:

- Broadcom BCM2837 64bit Quad Core Processor powered Single Board Computer running at 1.2GHz
- 1GB RAM
- BCM43143 WiFi on board
- Bluetooth Low Energy (BLE) on board
- 40pin extended GPIO
- 4 x USB 2 ports
- 4 pole Stereo output and Composite video port
- Full size HDMI
- CSI camera port for connecting the Raspberry Pi camera
- DSI display port for connecting the Raspberry Pi touch screen display
- Micro SD port for loading your operating system and storing data
- Upgraded switched Micro USB power source (now supports up to 2.4 Amps)
- Expected to have the same form factor has the Pi 2 Model B, however the LEDs will change position

PRINCIPAL

Geethanjali College of Engg. Tech.  
Cheerl (V), Keesara (M), R.R. Dist. (A.P.) - 501 301



# Raspberry Pi2 GPIO Header

Pin#	NAME		NAME	Pin#
01	3.3v DC Power	● ●	DC Power 5v	02
03	GPIO02 (SDA1 , I <sup>2</sup> C)	○ ●	DC Power 5v	04
05	GPIO03 (SCL1 , I <sup>2</sup> C)	○ ●	Ground	06
07	GPIO04 (GPIO_GCLK)	○ ○	(TXD0) GPIO14	08
09	Ground	● ○	(RXD0) GPIO15	10
11	GPIO17 (GPIO_GEN0)	○ ○	(GPIO_GEN1) GPIO18	12
13	GPIO27 (GPIO_GEN2)	○ ●	Ground	14
15	GPIO22 (GPIO_GEN3)	○ ○	(GPIO_GEN4) GPIO23	16
17	3.3v DC Power	○ ○	(GPIO_GEN5) GPIO24	18
19	GPIO10 (SPI_MOSI)	○ ●	Ground	20
21	GPIO09 (SPI_MISO)	○ ○	(GPIO_GEN6) GPIO25	22
23	GPIO11 (SPI_CLK)	○ ○	(SPI_CE0_N) GPIO08	24
25	Ground	● ○	(SPI_CE1_N) GPIO07	26
27	ID_SD (I <sup>2</sup> C ID EEPROM)	○ ○	(I <sup>2</sup> C ID EEPROM) ID_SC	28
29	GPIO05	○ ●	Ground	30
31	GPIO06	○ ○	GPIO12	32
33	GPIO13	○ ●	Ground	34
35	GPIO19	○ ○	GPIO16	36
37	GPIO26	○ ○	GPIO20	38
39	Ground	● ○	GPIO21	40

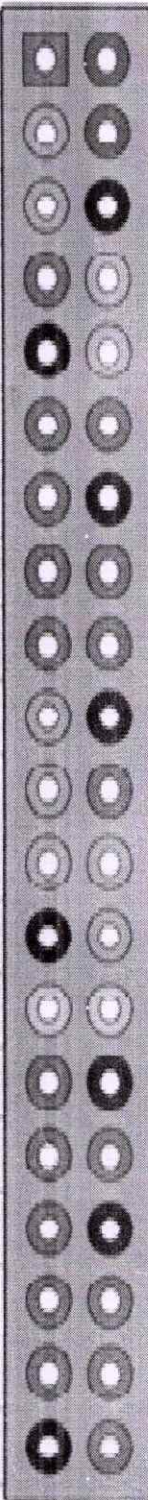





Tech Support: [services@elecfreaks.com](mailto:services@elecfreaks.com)

## Ultrasonic Ranging Module HC - SR04

### Product features:

Ultrasonic ranging module HC - SR04 provides 2cm - 400cm non-contact measurement function, the ranging accuracy can reach to 3mm. The module includes ultrasonic transmitters, receiver and control circuit. The basic principle of work:

- (1) Using IO trigger for at least 10us high level signal,
- (2) The Module automatically sends eight 40 kHz and detect whether there is a pulse signal back.
- (3) IF the signal back, through high level, time of high output IO duration is the time from sending ultrasonic to returning.

Test distance = (high level time  $\times$  velocity of sound (340M/S)) / 2,

### Wire connecting direct as following:

- 5V Supply
- Trigger Pulse Input
- Echo Pulse Output
- 0V Ground

### Electric Parameter

Working Voltage	DC 5 V
Working Current	15mA
Working Frequency	40Hz
Max Range	4m
Min Range	2cm
Measuring Angle	15 degree
Trigger Input Signal	10uS TTL pulse
Echo Output Signal	Input TTL level signal and the range in proportion
Dimension	45*20*15mm

PRINCIPAL  
Geethanjali College of Engg. Techn.  
Cheeryal (V), Keesara (M), R.R. Dist. (A.P.) - 501 301



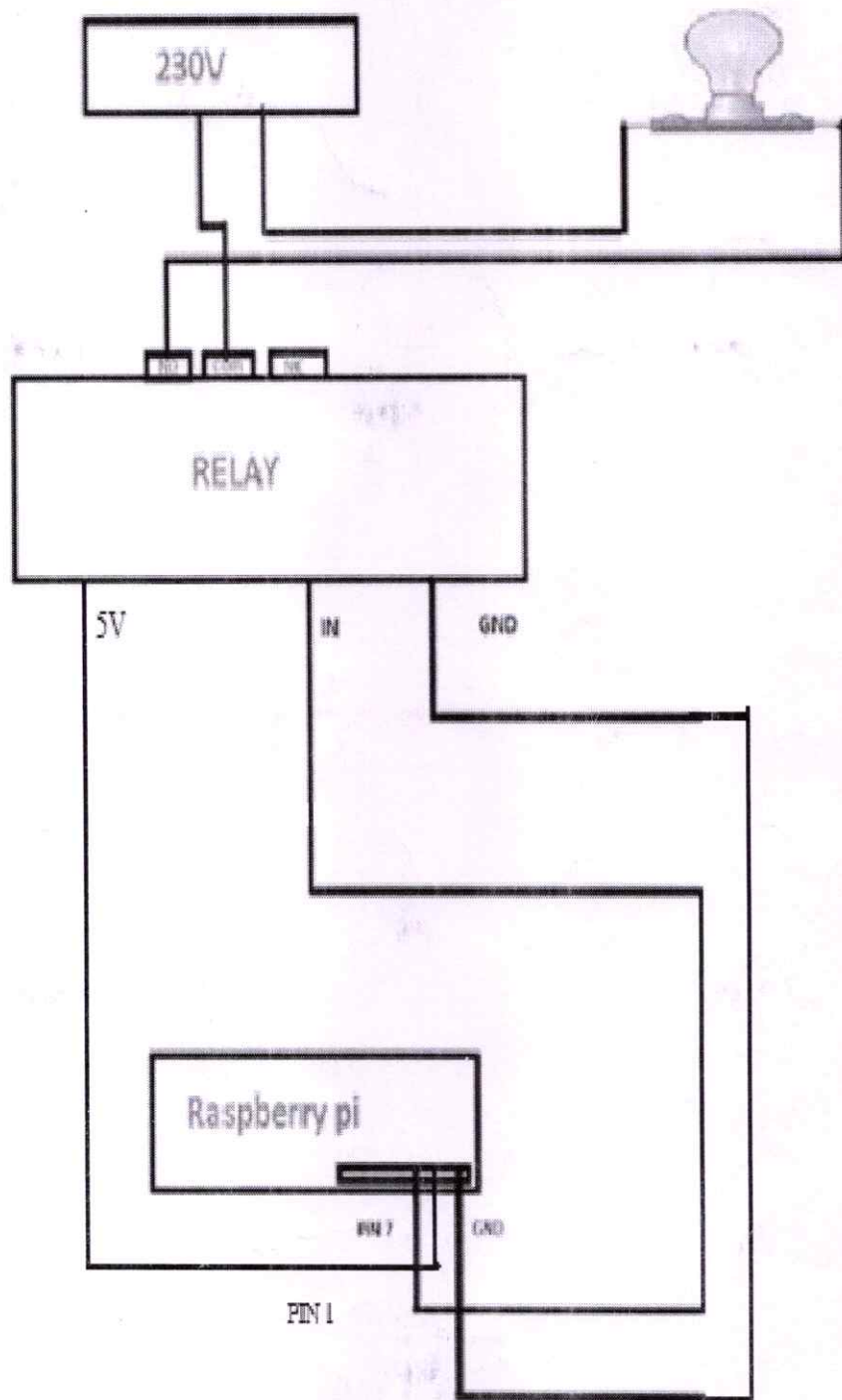

PRINCIPAL  
Geethanjali College of Engg. Techn.  
Cheeryal (V), Kaesara (M), R.R. Dist. (A.P.) - 501 301



GEETHANJALI COLLEGE OF ENGINEERING AND TECHNOLOGY

BOOT CAMP STUDENT LIST

S.No	Name	Roll No	Branch	Phone	Email
1	C. Prathyusha	16R11A0508	CSE A	6300524858	prathyushac98@gmail.com
2	P. Carol Navya	16R11A05E5	CSE D	9618176142	carolnavya1999@gmail.com
3	P. Arvind Tilak	16R11A0335	Mech	9177003048	thilakarvind@gmail.com
4	Majeti Eswar Hemanth	16R11A0427	ECE	8885319264	eswar.hemanth143@gmail.com
5	A. Koushik	16R11A0497	ECE	9704998784	kaushik.adusumilli9@gmail.com
6	C. Sai Ram Rao	15R11A0408	ECE	7075653264	sairamrao96@gmail.com

*(Handwritten mark)*

**PRINCIPAL**  
Geethanjali College of Engg. Tech.  
Cheeryal (V), Koesara (M), R.R. Dist. (A.P.) - 501 306

Geethanjali College of Engg. Tech.  
Cheeryal (V), Koesara (M), R.R. Dist. (A.P.) - 501 306



## Lab Experiment-1

**Aim:** Flashing the Raspbian OS on to the Raspberry Pi 3 Model B Board with necessary packages using the latest NOOBS v2.1.0 software.

**Software Requirement:** NOOBS v2.1.0, SD Card Formatter

**Hardware requirement:**

- 1) Raspberry Pi 3 (Broadcom BCM 2837/2835) Model B,
- 2) 5 V micro USB power supply
- 3) A micro SD card at least 4GB, SD card reader
- 4) PC with Windows OS, HDMI to VGA female Cable, USB Keyboard and USB mouse.

**Circuit Diagram:**

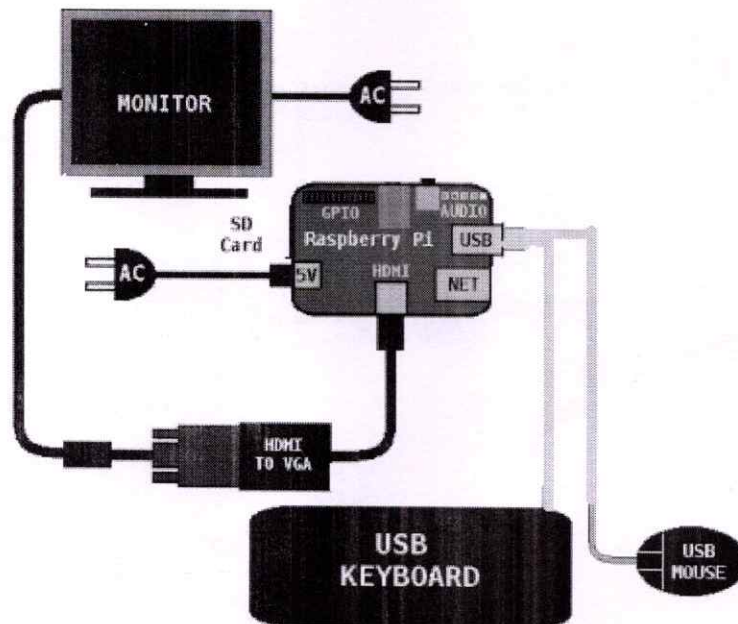

**Procedure:**

To install a Raspberry Pi operating system image on an SD card. You will need another computer with an SD card reader to install the image.

**Step1**

**1) Formatting an SD card**

1. Insert the SD card into SD card reader
  2. Connect SD card reader to USB port of PC/Laptop
- To format an SD card that is 4GB or larger as FAT
3. Download the SD card formatter; run this from a USB drive
  4. Format SD card.
  5. Exit the imager and eject the SD card



- f) Blinking Status of red LED shows that Raspberry Pi is working fine.

## Step 2

### Check that ssh to Pi works ok

- To know the IP address of Raspberry Pi, type **ifconfig** on the Pi terminal
- You will see against eth0 there is a Inet Addr entry, usually a 192.168.1.x number but might be different on different systems.
- Make sure a network cable of one end is connected to PC and another end to Raspberry Pi.
- Use the downloaded putty software or Download – Putty from <http://www.chiark.greenend.org.uk/~sgtatham/putty/download.html>
- Double click on putty and run to start application. Depending on which cluster you are using. Enter IP address (fotcluster) of Raspberry Pi in the host Name. Ensure Connection Type is SSH. Enter Cluster Name or something you will remember in Saved Sessions. Click to save.

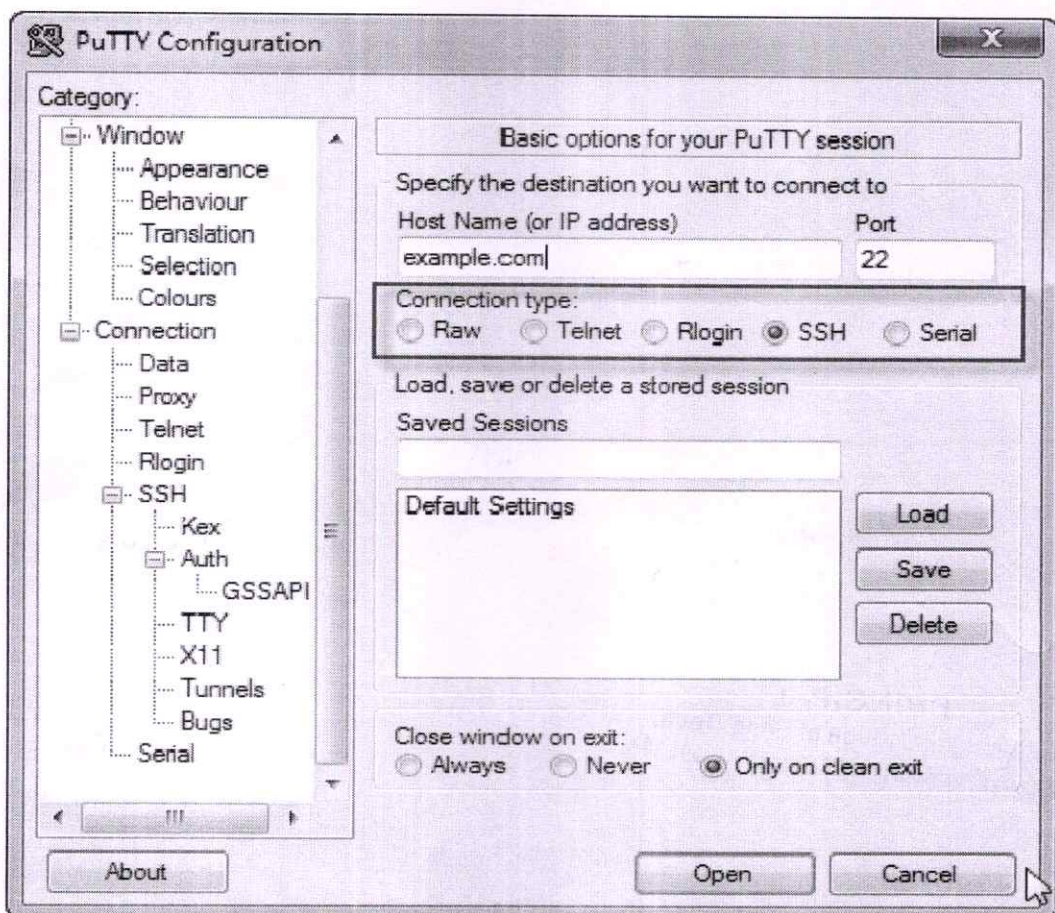



i) Then press OPEN.

You then see:

login as: **pi**

press Enter and the default password is **raspberry**

- You now have a shell on your windows PC that is connected to the Raspberry Pi. Anything you type here will run on the Raspberry Pi, and the results sent to this window. You can open multiple windows and be logged in multiple times.

### 3. Install xming for windows

Open xming from the start/all programs/xming/xming with a right-click and “run as administrator”. The xming icon appears in system tray.

### 4. Full desktop mode

- 1) To get full desktop mode working, use the xlaunch program from the xming menu.start/all programs/xming/xlaunch (right-click run as administrator)
- 2) Choose “one window” and set the display number to 1
- 3) You can have any number of display servers running, but each must have a unique display number. As you have already used display 0 (you configured this in putty ssh/x11/X display location remember?), we’ll use logical display 1 for the full desktop so you can leave all your other windows open.
- 4) Click NEXT> then click “start a program”
- 5) Click NEXT> then enter startlxde in the start program box
- 6) Run remotely using putty.exe
- 7) Type in the ip address of your Raspberry Pi, the username pi and the password raspberr.
- 8) click NEXT> then NEXT> then FINISH

### Precautions:

1. Insert micro SD card properly
2. Connect network cable properly
3. Do not connect the power supply to Raspberry Pi initially
4. Properly insert Raspberry Pi 3 board in to Raspberry Pi case



## Switching an LED ON AND OFF

### Procedure:

GPIO Zero is a new Python library which provides a simple interface to everyday GPIO components. It comes installed by default in Raspbian.

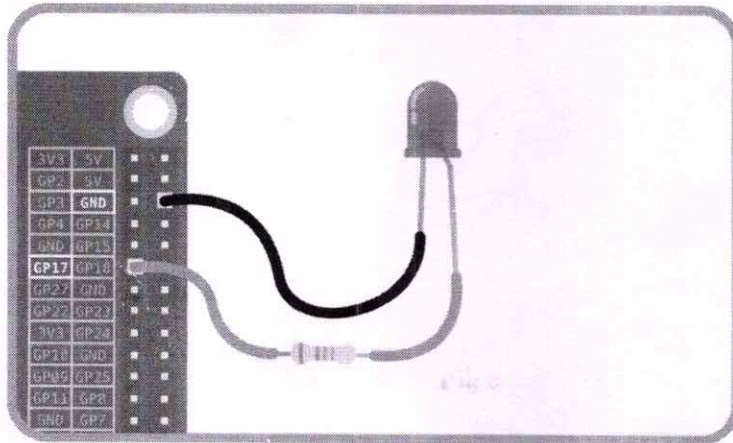

```
from gpiozero import LED
```

```
led = LED(17)
```

1. To make the LED switch on, type the following and press **Enter**:

```
led.on()
```

2. To make it switch off you can type the following and press **Enter**

```
led.off()
```

Your LED should switch on and then off again. But that's not all you can do.

## MANUALLY CONTROLLING AN LED ON AND OFF BY PRESSING A SWITCH

### Procedure:

1. Connect the circuit as shown above
2. Repeat steps 2&3 of above procedure
3. Create a new file by clicking **File > New file**.
4. Save the new file by clicking **File > Save**. Save the file as `gpio_switch.py`.
5. Now write the following code:
6. **from gpiozero import LED, Button**
7. **from time import sleep**
8. **led = LED(17)**
9. **button = Button(2)**
10. **button.wait\_for\_press()**
11. **led.on()**



To  
The Principal,  
Geethanjali College of Engineering and Technology,  
Cheeryal, Keesara, Medchal.

Date: 17 Feb 2017

Subject: Letter for approval of acquisition of Server Admin Rights.

Sir,

We the members of Geethanjali College Mobile App Project require a sub-domain within the college's server, so as to maintain secured data. Therefore, we kindly request you to please provide us with the approval and the rights to access the college's server domain.

Thanking you.

Yours faithfully,

Geethanjali Android App Development Team

Rahul N D - 14R11A05F6

I Bhavana - 14R11A05D3

P Saiesh - 14R11A05F2

Respected Sir,  
We need ~~the~~ a sub-domain to be created & space for databases to be set up (MySQL). We may need about 10GB space to start with to run the app. successfully. Request you to please approve the same.

OK  
Prof. Chandrababu is requested to take care of this.

Sir  
9/18/02/17

17/2/17

PRINCIPAL  
Geethanjali College of Engg. Tech.  
Cheeryal (V), Keesara (M), R.R. Dist. (A.P.) - 501 306



# Geethanjali College Of Engineering and Technology

(An UGC Autonomous Institution, Accredited by NBA, NAAC "A" Grade, Approved by AICTE and Permanently Affiliated to JNTUH)

Cheeryal(V), Keesara(M), Medchal Dist, (T.S)- 501301

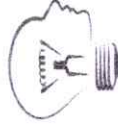

INNOVANT  
TECHNOCRAT CLUB

## Certificate Of Appreciation Presented to

Mr. Rahul.N.D

PRINCIPAL  
Geethanjali College of Engg. Techn.  
Cheeryal (V), Keesara (M), R.R. Dist. (A.P.) - 501 301

In Recognition of your efforts in Designing and Developing the "Geethanjali College App."

Prof. N. Chandrakanth  
Co-ordinator - ITC

Dr. S. Udaya Kumar  
Principal



# Geethanjali College Of Engineering and Technology

(An UGC Autonomous Institution, Accredited by NBA, NAAC "A" Grade, Approved by AICTE and Permanently Affiliated to JNTUH)

Cheeryal(V), Keesara(M), Medchal Dist, (T.S)- 501301

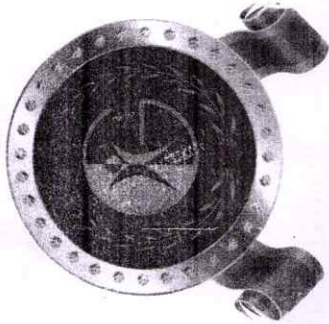

## Certificate Of Appreciation Presented to

**Ms. Bhavana Na**

In Recognition of your efforts in Designing and Developing the "Geethanjali College App."

PRINCIPAL  
Geethanjali College of Engineering and Technology  
Cheeryal (V), Keesara (M), Medchal Dist, (T.S) - 501301

Prof. N. Chandrakanth  
Co-ordinator - ITC

Dr. S. Udaya Kumar  
Principal





Geethanjali College of Engineering and Technology  
(UGC Autonomous)  
CHEERYAL (V), KEESARA (M) - 501301, Telangana, India

Sl. No.	Name of Project	Student Details		Status
		Name	Roll No	
Year: 2016-17				
1	Sensor based guide for Blind	S. Nagalakshmi Saivenkata Tarun Abhijeet Kumar Ram Kaushik Rahul Sai	15R11A0530 15R11A0479 14R11A04J0 15R11A05J2 15R11A05E7	Work in progress. Design complete. Component Procurement complete.
2	Electricity generation using piezo electricity	Virendranath Santosh Sadiq Madhavi	15R11A0483 15R11A0341 15R11A0350 15R11A0472	Work in progress. Design complete. Component Procurement complete.
3	Automated Switch for High beam light in vehicles	B. Thejesh G. Bharath K.J.C. Pavan Kumar P. Grishma D.V.N. Ramya	15R11A0312 15R11A05K5 15R11A0482 15R11A05A0 15R11A05K3	Work in progress. Design complete. Component Procurement complete.
4	Automated parking slot Detection System	T. Srikar Pranav Raju B. Kireeti	15R11A0352 14R11A0M6 14R11A0482	Work in progress. Design complete. Component Procurement complete.
5	Bicycle Mobile Charger	D.V. Varma Venkat Shreyas Hameed	15R11A0315 15R11A0244 15R11A05B8 15R11A04L5	Work in progress. Design complete. Component Procurement complete.
6	SOUND - Generation of power from various sounds	Bharadwaj Vishal Tanmayi Sujana Manikanta	15R11A0314 15R11A0343 15R11A05A5 15R11A0493 15R11A04F2	Work in progress. Design complete. Component Procurement complete.
7	Smart Switch	S. Piyush Harshith K.V. Nikhil Shiva Kumar	15R11A0248 15R11A0585 15R11A0168 15R11A05H6	Work in progress Design complete. Component Procurement complete.

Events Conducted:

1	Portal update for the students to join incubation Center
2	General session on Creativity and Innovation
3	Update Sessions/Discussions
4	Raspberry PI Workshop

Head  
Dept. of Computer Science & Engg  
Geethanjali College of Engg. & Tech.  
Cheeryal (V), Keesara (M), R.R. Dist. (A.P.) - 501301

PRINCIPAL  
Geethanjali College of Engg. Tech.  
Cheeryal (V), Keesara (M), R.R. Dist. (A.P.) - 501301





Geethanjali College of Engineering and Technology  
(UGC Autonomous)

CHEERYAL (V), KEESARA (M) - 501301, Telangana, India

Sl No	Course Name
1	Creativity and Innovation Presentation
2	Arduino Basics
3	Raspberry PI Basics

*[Handwritten signature]*

**Head**

Dept. of Computer Science & Engg.  
Geethanjali College of Engg. &  
Tech. (A.P.)  
Cheeryal (V), Keesara (M), R.R. Dist. (A.P.)

*[Handwritten mark]*

PRINCIPAL  
Geethanjali College of Engg. Tech.  
Cheeryal (V), Keesara (M), R.R. Dist. (A.P.) - 501 301





Geethanjali  
College of Engineering and Technology  
*...Striving Towards Perfection*

## SELF TRIGGERING ACCIDENT RESPONSE SYSTEM (S.T.A.R.S)

Satyanarayana Konala  
(13R11A0325)

Akshay Viswajith  
(13R11A04L1)

Archana Dash  
(13R11A04F8)

Shruti Singh  
(12R11A0553)

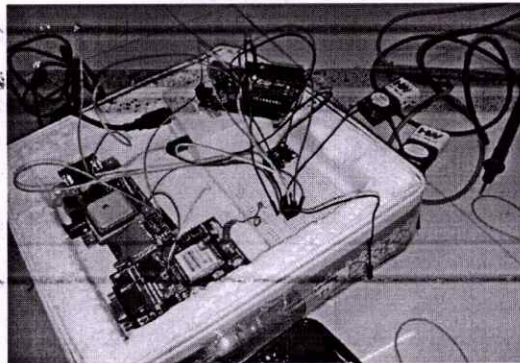

**Problem Statement:** We all are familiar with the fact that these days accidents have become very common. Though the accidents are not that fatal, the delay in deploying emergency services on time becomes a major factor in deciding the fate of the victim.

**Solution Statement:** A device that will measure the acceleration and inclination values of the vehicle to determine if there is a crash or accident. In case of an accident, an message will be relayed to a control tower or a hospital(which is pre programmed).

**Prototype Design:** Accelerometer and gyroscope are connected to a microcontroller which is coded to measure the values of acceleration and inclination. When a sudden change is detected by the device, a GSM module is triggered which sends a distress signal to the pre programmed number belonging to either a control tower or an emergency response unit.

IN CASE OF AN ACCIDENT AN MESSAGE WILL BE RELAYED TO A CONTROL TOWER OR A HOSPITAL WHICH IS PRE PROGRAMMED.

Geethanjali College of Engg. Tech.  
Cheeruvu (V), Keesara (M), R.R. Dist. (A.P.) - 501 302



A helping hand for the farmers.

## SPRAY-COPTER

### PROBLEM

- > The problem generally faced by the farmers is to manually spray the pesticides and fertilizers.
- > As we can see in the picture the one who sprays the pesticide/fertilizer must take proper care while doing it.
- > Any negligence while doing this leads to fatal consequences.
- > Also there is a lot of human labour involved in this spraying technique.
- > If we find a solution to these problems we can save farmers from these fatal diseases and also reduce human labour.



### OUR APPROACH

- We can solve this problem by approaching it with technology.
- Although we have existing technology for this, they are beyond a regular farmer's budget.
- We would like to make a product which every farmer can afford with ease.



### SOLUTION

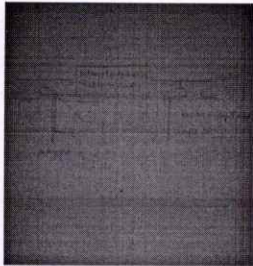

- Our machine is a quadcopter carrying a pesticide tank, which will spray pesticide/fertilizer flying at a low level on the crops with a camera.
- This can be configured and operated by any person as its working is basic.
- The camera in the copter helps us in analyzing the condition of the crop.

### WORKING

- Our design is a unmanned agricultural vehicle(UAV).
- It is a quad copter on which a spraying mechanism and containers are mounted on the top, or fixed at the bottom.
- The quad copter is made to fly above the crop in the field using a radio control or automation applications
- The spray can be modulated and thrown on the crop when the quad flies .

### SPECIFICATIONS

<ul style="list-style-type: none"> <li>▪ Components:</li> <li>▪ Quad copter frame..</li> <li>▪ Width 450 mm</li> <li>▪ Flight controller- apm</li> <li>▪ neo 6m GPS</li> <li>▪ Multi rotor 4 in 1 ESC</li> <li>▪ Multi star brushless motor 640 kv -4</li> <li>▪ Haiyin 3s battery</li> <li>▪ Digital cam coder</li> <li>▪ Brushless water pump</li> <li>▪ 7 g nozzle</li> <li>▪ Plastic container 2l</li> </ul>	<ul style="list-style-type: none"> <li>▪ A quad copter is designed for an excess payload of 2 kgs</li> <li>▪ A container and spraying mechanism is fixed to it</li> <li>▪ Connectors and binders</li> <li>▪ 2.4 GHz receiver and transmitter</li> <li>▪ 10 cm male to male servos</li> <li>▪ 9gm servos</li> <li>▪ Rubber tubes 6 to 9 mm</li> <li>▪ Propellers -4</li> </ul>
--	---

PRINCIPAL  
Geethanjali College of Engg. Tech.  
Chaeryal (V), Kaeruru (M), R.R. Dist. (A.P.) 507364





Geethanjali  
College of Engineering and Technology  
...Striving Towards Perfection

## SPRAY-COPTER

Padmaja Nistala  
(12R11A1298)

Raghu Varun  
(12R11A0585)

Sai Anjana  
(12R11A0545)

Rohith Shashank  
(13R11A04J1)

Ruthwik Edara  
(13R11A0342)

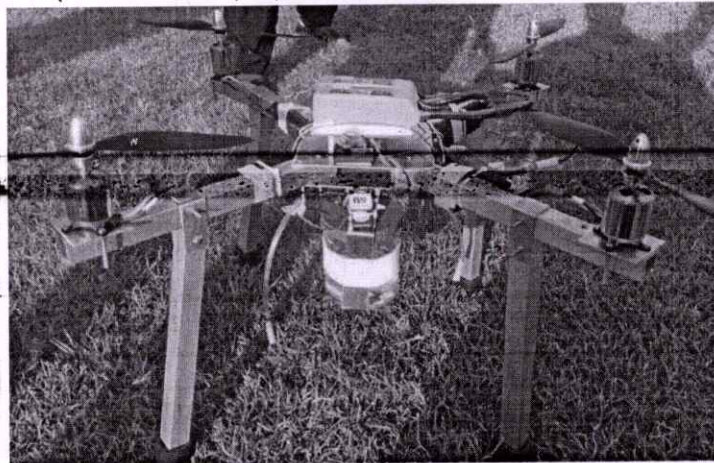

**Problem Statement :** problem generally faced by the farmers is to manually spray the pesticides and fertilizers. This could cause Skin diseases, Genetic disorders, Effect on children's immune system, Disorders in regular metabolic activities.

**Solution Statement :** We can solve all these issues by building a technology which is accessible and affordable by any farmer. Our idea was to build a unmanned agricultural vehicle(UAV) which can reduce the workload, labour and also fatal diseases for farmers.

**Prototype Design:** SPRAY-COPTER which can overcome the problems like price, labour, time and safety of the farmers. The main aim of this was to be a helping hand to the farmers. It is a quad-copter which can carry the pesticide, and spray it in the agricultural fields according to the user requirement.

*(Handwritten signature)*

PRINCIPAL  
Geethanjali College of Engg. Tech  
Cheruvu (V), Kasur (M), R.R. Dist. (A.P.) - 501 301



A helping hand for the farmers.

## SPRAY-COPTER

### PROBLEM

- The problem generally faced by the farmers is to manually spray the pesticides and fertilizers.
- As we can see in the picture the one who sprays the pesticide/fertilizer must take proper care while doing it.
- Any negligence while doing this leads to fatal consequences.
- Also there is a lot of human labour involved in this spraying technique.
- If we find a solution to these problems we can save farmers from these fatal diseases and also reduce human labour.



### OUR APPROACH

- We can solve this problem by approaching it with technology.
- Although we have existing technology for this, they are beyond a regular farmer's budget.
- We would like to make a product which every farmer can afford with ease.

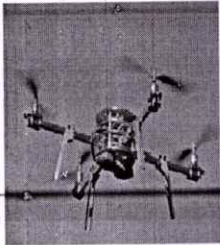

### SOLUTION

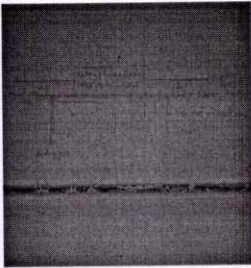

- Our machine is a quadcopter carrying a pesticide tank, which will spray pesticide/fertilizer flying at a low level on the crops with a camera.
- This can be configured and operated by any person as its working is basic.
- The camera in the copter helps us in analyzing the condition of the crop.

### WORKING

- Our design is a unmanned agricultural vehicle(UAV).
- It is a quad copter on which a spraying mechanism and containers are mounted on the top, or fixed at the bottom.
- The quad copter is made to fly above the crop in the field using a radio control or automation applications
- The spray can be modulated and thrown on the crop when the quad flies .

### SPECIFICATIONS

- Components:
- Quad copter frame.. Width 4,50 mm
- Flight controller- apm, neo 6m GPS
- Multi rotor 4 in 1 ESC
- Multi star brushless motor 6,40 kv -4
- Haiyin 3s battery
- Digital cam coder
- Brushless water pump
- 7 g nozzle
- Plastic container 2l
- A quad copter is designed for an excess payload of 2 kgs
- A container and spraying mechanism is fixed to it
- Connectors and binders
- 2,4 GHz receiver and transmitter
- This can be configured
- 10 cm male to male servos
- 99m servos
- Rubber tubes 6 to 9 mm
- Propellers -4

PRINCIPAL  
Geethanjali College of Engineering & Technology  
Chennai (V), Kanchipuram (M), K.K. Dattaguru, 2013-2014



## PlaPER

# Plastic Pelletizer, Extruder and Recycler. Geethanjali College of Engineering & Technology

(Affiliated to J.N.T.U.H, Approved by AICTE, NEW DELHI)



An interdisciplinary project from from Electronic and Communication Department,  
Computer Science Department and Mechanical Department.

By,

Satyanarayana Konala  
13R11A0325  
[satya130896@gmail.com](mailto:satya130896@gmail.com)

D. Mahadev Bhatt  
13R11A0325  
[bhatt.devaraju@gmail.com](mailto:bhatt.devaraju@gmail.com)

G. Viswajith  
13R11A04L1  
[akshayviswajith27@gmail.com](mailto:akshayviswajith27@gmail.com)

Rohit Shashank  
13R11A04J1  
[msaisashank@gmail.com](mailto:msaisashank@gmail.com)

Spoorthy Punna  
13R11A05  
[punnaspoorthy96@gmail.com](mailto:punnaspoorthy96@gmail.com)

Sheetal Marakala  
12R11A03  
[marakalasheetal@gmail.com](mailto:marakalasheetal@gmail.com)

PRINCIPAL  
Geethanjali College of Engineering & Technology,  
Cheeryal (V), Keerthi (M), R.R. Dist. (A.P) - 501 307



## Table of Contents

Title Pages

Table of Contents

Project Management Plan

- Overview
- Scope and Objectives

Analysis and Existing Projects (to be added)

Basic Idea

Design

Use Case Diagrams (to be added)

Implementation (to be added)

Test Documentation (to be added)

References

PRINCIPAL  
Geethanjali College of Engg. Tech  
Cheeryal (V), Keesara (M), R.R. Dist. (A.P.) - 501 304



## Overview

Garbage is a major concern which has to be addressed on a war footing basis. Many environmentalists and other NGOs have been doing their best in educating the people and helping out with recycling, the amount of unrecyclable and discarded plastics has by and large proved to be a nerve-wrecking ordeal. According to a recent survey the amount of unrecyclable and discarded plastics in the US alone comes close to 30 million tons annually, apart from things like disposable coffee cups. It is believed that the Americans throw nearly 2.5 billion disposable cups every year. India is a highly populated country. Firstly, with its plans to grow industrially and agriculturally, proper disposal of plastic and waste management has to be taken up immediately. Secondly, people of India turn a blind eye towards hygiene and waste management. In this grave situation, proper disposal of plastic and waste management is the need of the hour. This performs a key role in making the earth a safe place to live and aids in moving towards a safe and healthy environment.

Polythene bags and PET bottles constitute more than \_\_\_% of the world's pollution. (Please mention the % of green house gases and CFCs also for comparison) This might look pale in comparison to effluents like greenhouse gases and CFCs but it cannot be denied that they are a major cause of concern not only to human life, and also to the environment. The fact that people take little care in disposing these plastic without any regard to the consequences is scary, and if this practice is continued, it would lead to a global scale disaster. To bring things into control, the Pacific Ocean houses the two largest dump yards on this planet. This kills more aquatic life than most events ever did.

Large amount of waste is produced, which is not managed efficiently and productively. If this situation continues it is disastrous to environment, flora and fauna and to human beings.



PRINCIPAL  
Geethanjali College of Engg. Tech.  
Cheeryal (V), Keesara (M), R.R. Digi. (A.P.) - 501 301



## Scope and Objectives

Create a compact machine which automatically shreds, cleans, melts and forms the plastic into small pellets which can be bagged and sent off for recycling/reuse. The machine can be put in villages and crowded places, where people can dispose off plastic waste in the machine.

Advantages:

1. Lesser impact of stray plastic waste.
2. Easier waste collection
3. Revenue generation

## Basic Idea

### Initial Processing

- Once the plastic has been collected, it will have to be cleaned and sorted.
- The techniques used will depend on the type of waste collected. At a more simple level it involves hand washing and sorting the plastic into the required groups.
- Sorting of plastics can be by polymer type (thermoset or thermoplastic for example), by product (bottles, plastic sheeting, etc.), by colour, etc.

### Shredding

- **Materials** are fed into the shredder via a hopper which is situated above the blade rotor.
- The product of shredding is a pile of coarse irregularly shaped plastic flakes which can then be further processed.

### Extrusion

- The process of extrusion is employed to homogenize the reclaimed polymer and produce a material that is subsequently easy to work.
- The reclaimed polymer is then fed to the extruder.

PRINCIPAL  
Geethanjali College of Engg. Tech.  
Cheeraj (V), Keesara (M), R.R. Dist. (A.P.) - 501 301



### Pelletization

- The pelletization process is used to reduce the semi solid polymer which is extracted from extruder to pellets.
- Pellets can then be used for the manufacture of new products.

### Design

The prototype has a plastic shredder into which sorted polythene bags and bottles are fed through a hopper. The shredded plastic then falls into a metal cylinder which houses an Archimedes screw. The periphery of the cylinder is surrounded by heating coils, which softens the plastic. The plastic is then pushed by the screw mechanism through a perforated plate, which extrudes the plastic into noodle like shapes, which are cut by a blade that rotates along with the screw. Most of the machines these days smelt plastic or they shred it, both of which are not efficient enough to reduce the leviathan like garbage which is added to the environment every day. After much brainstorming it is understood that, a need for a machine that combines both the processes in a better and easy manner is needed. Therefore an idea to design a machine that combines both the processes and makes the whole process simple and effective is thought of.

#### Basic design of a plastic shredder unit

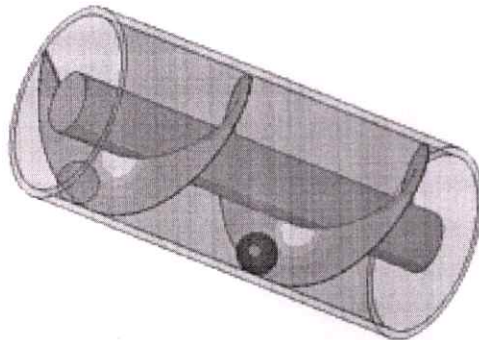

Archimedes screw mechanism

*(Handwritten signature in green ink)*

**PRINCIPAL**  
Geethanjali College of Engg. Techn.  
Cheeryal (V), Keesara (M), A.P. Dist. (A.P.) - 501 301.



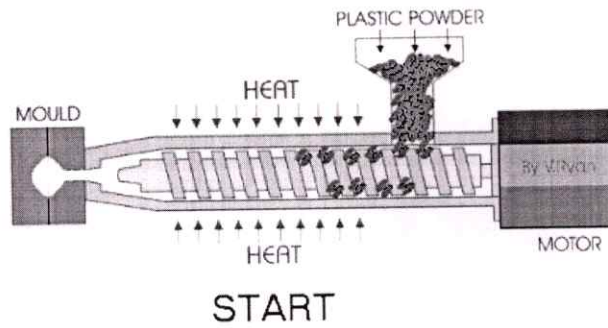

Melting and extruding the shredded plastic

Comment [1]: <http://www.treehugger.com/sustainable-product-design/diy-pet-bottle-shredding.html>

Comment [2]: dekha?

Comment [3]: only shredder hai na re

- Use Case Diagrams
- Test Cases
- Implementation

#### Did you know...

- According to the National Association for PET Container Resources (NAPCOR), at 37.46%, the recycling rate for single-serve PET plastic bottled water containers more than doubled between 2003-2014.
- According to the EPA, plastic bottles make up less than one-third of one percent of the waste stream.
- Of all the plastics produced in the United States, PET plastic bottled water packaging makes up only 0.92%.
- Between 2000-2014, the average weight of a 16.9-ounce PET plastic bottle has declined 48% to 9.89 grams, saving 6.2 billion pounds of PET resin since 2000.
- All PET bottled water containers are 100% recyclable.
- Recycling infrastructure for PET is well-established, from widespread collection and separation to processing and end use.

*(Handwritten signature)*

**PRINCIPAL**  
**Geethanjali College of Engg. Tech.**  
 K. P. Narayana (M), R. R. Dist. (A.P.)-501 307



- PET can be recycled multiple times.
- Virtually all recycling programs in the United States accept PET containers.
- The first PET bottle was recycled in 1977.
- More than 1.5 billion pounds of PET were recycled in 2010 and more than 1 billion pounds of recycled PET material was used in U.S. and Canadian end-products.

PRINCIPAL  
Geethanjali College of Engg. Tech  
(Cheerayal (V), Keesara (M), R.R. Dist. (A.P.) - 507 306)

125 KVA T/12

1. 27855 kWh
2. 26309 kWh
3. 19516 kWh
4. 23773 kWh
5. 26697 kWh
6. 22511 kWh
7. 19475 kWh
8. 15009 kWh
9. 15514 kWh
10. 15959 kWh
11. 19682 kWh
12. 17713 kWh

TOTAL:- 250013 kWh

200 KVA T/12

1. 12746 kWh
2. 16484 kWh
3. 11497 kWh
4. 14641 kWh
5. 15781 kWh
6. 12708 kWh
7. ~~85618~~ kWh
8. 4756 kWh
9. 4115 kWh
10. 4433 kWh
11. ~~4634~~ kWh
12. 5273 kWh

+ Total:- 112686 kWh

362699 kWh

1). Cafeteria = 5%.

2). Labs = 40%.

3). Office & class rooms & Gymnasium, water plant = 55%.

  
PRINCIPAL  
Geethanjali College of Engg. Tech.  
Cheerla (V), Keesara (M), R.R. Dist. (A.P.) - 501 301



Geethanjali College of Engineering and Technology has a total area of 40468.6 Square Meters with an approximate construction of 4645.152 Square Meters covering 11.47 % of the total campus area.

The entire campus is covered with gardens, trees and Landscapes covering an area of 35823.448 Square Meters which is 88.48 % of the total campus area.

The average annual rainfall is 36 MM as per IMD.

The college does not have any residents or hostels in the campus expect for few security personnel during night time. However, the occupants during day time including students and staff comprises about 3301 (2902 Students and 399 Staff).

The annual energy consumption of the organization is \_\_\_\_\_ Kwh with \_\_\_\_\_ Kwh Energy Intensity is \_\_\_\_\_ Kwh and CO<sub>2</sub> Emissions is approximately around \_\_\_\_\_ tons and \_\_\_\_\_ tons of Emissions Intensity.

The annual consumption of electricity at the cafeteria is around \_\_\_\_\_ % of the total energy Consumption of the college.

The annual consumption of electricity at the laboratories is around \_\_\_\_\_ % of the total energy Consumption of the college.

The annual consumption of electricity at the Offices and classroom buildings is around \_\_\_\_\_ % of the total energy Consumption of the college.

Consumption of Diesel is approximately around 18000 Kl, the emissions of CO<sub>2</sub> is 48060.00 tons per annum.

The organization does have any municipal water supply but has Reverse Osmosis (RO) plant with a capacity of 12 KL(generation is only 4000 Liters per day) which is totaling of 972 Kl (4000 L \*243 days).

The annual rain water harvesting is approximately \_\_\_\_\_ KL, the campus is divided into 4 Blocks and 1 cafeteria each of which has 6 rain water harvesting pits and the open area.

The annual water demand of the buildings is 5 KL which is \_\_\_\_\_ % of the annual water consumption of the organization.

The annual water demand of the cafeteria is 2 KL which is \_\_\_\_\_ % of the annual water consumption of the organization.

The annual water demand for landscaping/Gardening is 5 KL which is \_\_\_\_\_ % of the annual water consumption of the organization.

The per capita water intensity is \_\_\_\_\_ KL.

  
PRINCIPAL  
Geethanjali College of Engg. Tech.  
Cheeryl (V), Keeravani (M), R.R. Dist. (A.P.) - 501 002

## **Initiatives taken up by the organization for social and environmental relevance.**

### **NSS**

The NSS unit of the college provides social and community service in the near by villages. The college has adopted the village in which the college is located. As part of this, several activities are conducted. A few of them are

Blood Donation Camp

Health Camp

Dental Camp

Tree plantation

Around two hundred volunteers donated blood in each camp. The unit also organized a health camp to the benefit of villagers of Cheeryal village. Around 180 villagers were benefited by the camp. Books and stationery were collected from the staff and students of our college and distributed to the students of Primary School, Harijanavada School of Cheeryal village. NSS volunteers planted trees in and around Cheeryal village.

### **Eco Club:**

Eco club, has been organizing many eco-friendly events. Every year in the month of September we distribute eco friendly Ganesh idols to all the faculty members in order to create awareness about the dangerous effects of Plaster of Paris when mixed with water. In the year 2012 we have organized plantation program in Cheeryal village and planted about 100 samplings. This year in addition to the distribution of eco friendly Ganesh idols we also conducted awareness program in which students prepared ppts on environment protection and cleanliness in schools of Cheeryal village and that was a huge success.

The "Environmental club" was formed in the college in 2009. The committee works towards creating awareness of the hazards of environmental pollution among the students and involving them in tasks to minimize wastage of water, usage of plastics and increase of green cover.

**Special Research Projects:** LIDAR, Environment monitoring system are being developed to study the social problems like pollution, long term forecasting of weather conditions etc.

### **SwatchhBharath**

The organization is conducting swatch bharath program which is striving towards the clean and green campus which involves the faculty and the students for creating awareness among the students and Staff members.



# **BRAIN COMPUTER INTERFACE TRACKING FOCUS OF ATTENTION IN VEHICLES**

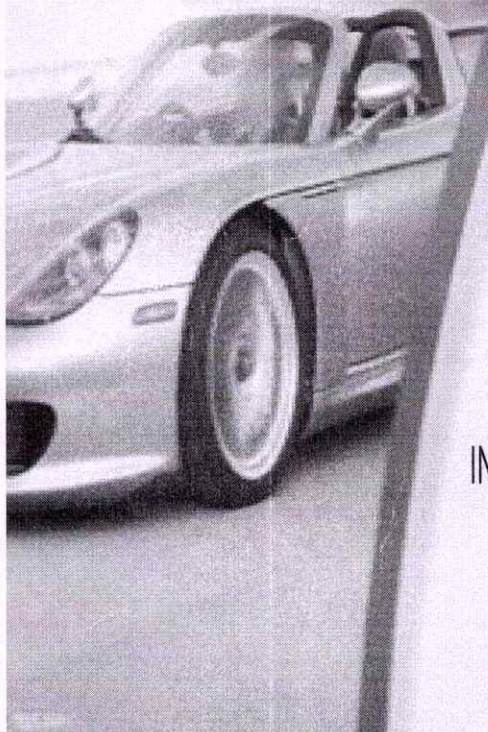

B. SOUJANYA (13R11A0508)

D. MURALI KRISHNA (13R11A0515)

S. TEJASWANI (13R11A0546)

INTERNAL GUIDE : Mrs. Madhuri Agrawal Gupta

D. MURALI

A handwritten signature in green ink, appearing to be 'D. Murali Krishna'.

PRINCIPAL  
Geethanjali College of Engg. Tech.  
Cheyral (V), Kavathi (M), R.S. Dist. (A.P.) - 501 301



## ABSTRACT

Drowsiness is becoming a severe issue in case of traffic accident. Normally, Sleeping can be identified from several factors like eye blink level, yawning, gripping force on wheel and so on. But all these measuring techniques will check only the physical activities of the human. In some cases, people will mentally sleep with eyes open for a few seconds. This will make very big accidents in driving. So, in our proposed project work we are analyzing the mental activities of brain using Electro Enciphalo Gram EEG signals based on Brain- Computer Interface (BCI) technology. The key work of the project is analyzing the brain signals. Human brain consists of millions of interconnected neurons. This neuron pattern will change according to the human thoughts. At each pattern formation unique electric brain signal will form. If a person is mentally sleeping with eyes open then the attention level brain signal will get changed than the normal condition. This project work uses a brain wave sensor which can collect EEG based brain signals of different frequency and amplitude and it will convert these signals into packets and transmit through Bluetooth medium in to the level splitter section to check the attention level. Level splitter section (LSS) analyze the level and gives the drowsy driving alert and keeps the vehicle to be in self controlled function until awoken state. This can save a lot of lives in road transportation.



PRINCIPAL  
Genthanjali College of Engg. Tech.  
Group (17), Bannur (M), R.R. 7th, A.P. - 501 202



# BLOCK DIAGRAM

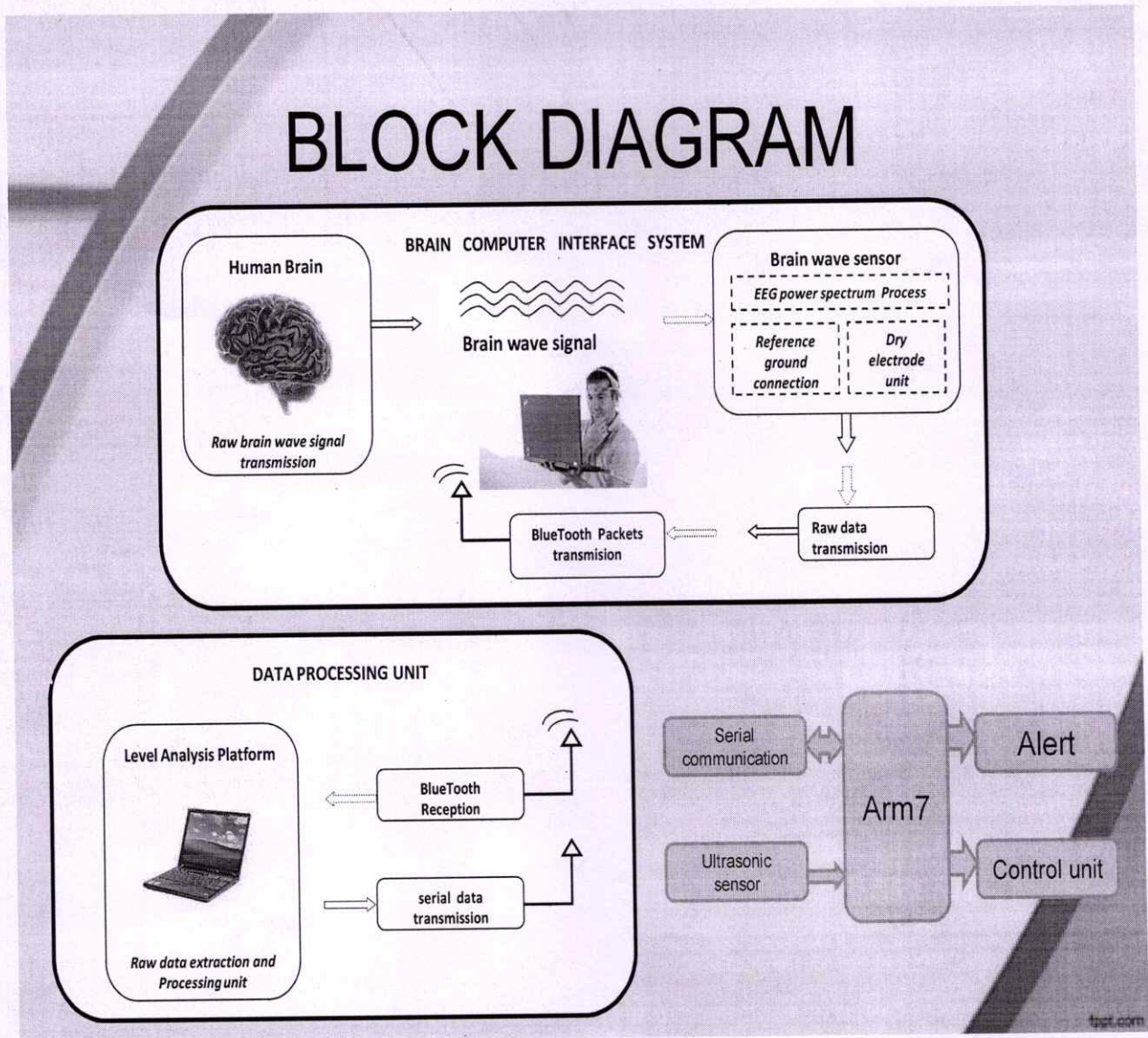

PRINCIPAL  
 Centennial College of Engg. Tech.  
 Changanassery (V), Kottayam (Dist), K.A. 084 (A.P.)-501 301

# Smart Agriculture Using IoT

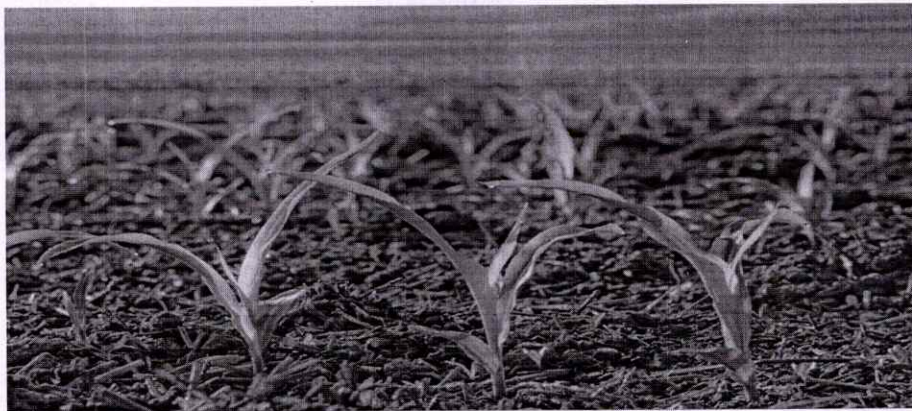

✓

PRINCIPAL  
Geethanjali College of Engg. Tech.  
Chouryal (V), Keesara (M), R.R. Dist. (A.P.) - 501 301



## ABSTRACT

The Internet of things (IOT) is remodeling the agriculture enabling the farmers with the wide range of techniques such as precision and sustainable agriculture to face challenges in the field. IOT technology helps in collecting information about conditions like chlorophyll content and nitrogen content leaf, Crop online monitoring enables detection of health of the plant, crop growth, and agriculture. IoT leverages farmers to get connected to his farm from anywhere and anytime. Wireless networks are used for monitoring the plant conditions. To view the conditions in the form of image and video, cameras have been used. A smart phone empowers farmer to keep updated with the ongoing conditions of his agricultural land using IoT at any time and any part of the world. IoT technology can reduce the cost and enhance the productivity of traditional farming.

With the proliferation of smart devices, Internet can be extended into the physical realm of Internet-of-Things (IoT) by deploying them into a communicating-actuating network. The potentialities of IoT can be brought to the benefit of society by developing novel applications in transportation and logistics, healthcare, agriculture, smart environment (home, office or plant). This research gives a framework of optimizing resources (fertilizers and manual labor) in agriculture through the use of IoT. The issues involved in the implementation of applications are also investigated. This frame work is named as AgriTech.



PRINCIPAL  
Geethanjali College of Engg. Tech.  
Geethanjali (V), Keesuru (S), R.R. Dist. (A.P.) - 501307

## HARDWARE REQUIREMENTS:

- 1.Raspberry pi 3 model b
- 2.Bluetooth Module
- 3.USB Webcam

## SOFTWARE REQUIREMENTS:

- 1.Android
- 2.Python
- 3.Cloud

S.NO	ROLLNO	NAME	EMAIL-ID	MOBILE NO	INSTITUTE
1.	13R11A05H8	Ankem LaxmiPrasanna	prasannaankem26@gmail.com	9949167265	Smart Bridge educational services Pvt Ltd (Nacharam)
2.	13R11A05K4	Goteti Lalitha Priyanka	lalithapriyanka.g@gmail.com	7095724262	
3.	13R11A05M4	Shravani Bajjuri	sweetyshravani95@gmail.com	9849610163	

PRINCIPAL  
Geethanjali College of Engg. Tech.  
Chervai (V), Keesara (M), R.S. Dist. (A.P.) - 501 304



## Actual Block Diagram

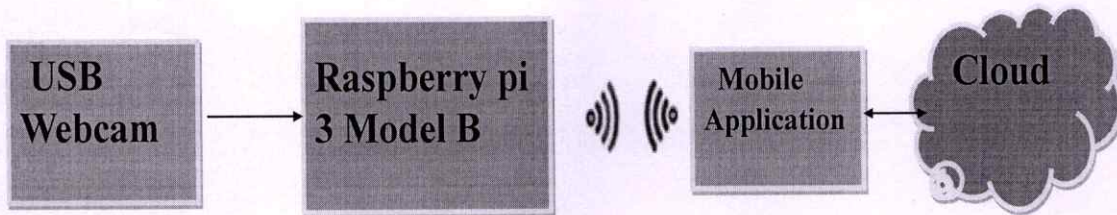

PRINCIPAL  
Geethanjali College of Engg. Tech.  
Chennai (T), Kancheepuram, R.R. Dist. (A.P.) - 501 307

# INTEGRATING WIRELESS SENSOR NETWORKS INTO INTERNET OF THINGS FOR SECURITY

## ABSTRACT

A Wireless Sensor Networks is a network consisting of spatially distributed autonomous devices using sensors to cooperatively monitor physical or environmental conditions. If we need access the data being generated by the nodes in the network from any distant locations, these Wireless Sensor Networks should be integrated to the Internet of Things (IoT).

Integrating Wireless Sensor Networks into Internet of Things is always a challenging task, there are many techniques to integrate the WSN and Internet, by applying these techniques a the nodes can directly communicate with the Internet which may lead to new challenges. One such challenge would be establishing a secure channel between a sensor node and internet host. There are lot of digital signatures and encryptions techniques to establish a secure channel but one should keep in mind the limited resources available in at the sensor node and one more constraint would be Public Key Cryptographic algorithms are not applicable to the sensor nodes because of high computational calculations. On the other hand Integrity Based Cryptographic schemes would be highly adaptable for Wireless Sensor Networks.

In this project we make combine IBC – PKI Cryptographic schemes to attain and establish a secure channel between sensor node and Internet host, we use heterogeneous online/offline sign-cryption scheme. So that secure





communication between sensor node and host is provided. We use diffie-hellman inversion problem, which provides indistinguishability against adaptive chosen cipher text attacks and existential unforgeability against adaptive chosen messages attacks.



PRINCIPAL  
Geethanjali College of Engg. Tech.  
Cheeryal (V), Keasara (M), R.R. Dist. (A.P.) - 501 307

# BLOCK DIAGRAM

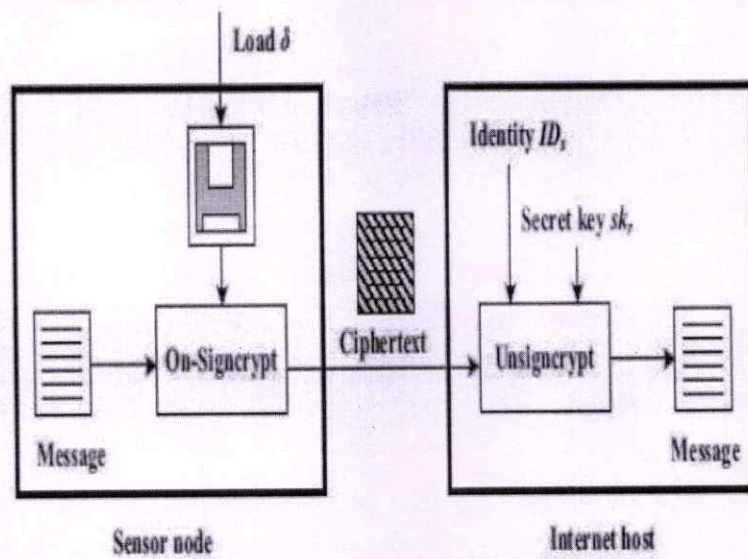

*[Handwritten signature]*

PRINCIPAL  
Geethanjali College of Engg. Techn.  
Choorayal (V), Keerasara (M), R.R. Dist. (A.P.) - 501 308



## OBJECT DETECTING WALKING STICK FOR VISUALLY IMPAIRED

PRESENTED BY

CH.BHARGAVI  
V.MOUNIKA

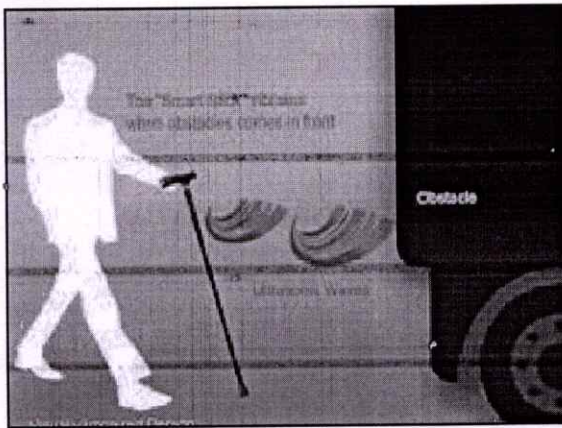

### ABSTRACT

- Blindness is a word frequently used to describe severe visual impairments with or without residual vision.
- The application of ultrasonic range scheme for producing electronic walking stick for the blind is technological advancement.
- There is a great dependency for any type of moment or walking within area or out of particular area, they use only their natural senses such as touch or sound for identification or walking.

- To overcome all these problems of blind people, we have devised a walking stick with simple technologies.
- This walking stick for blind people which have features include obstacle detection for collision avoidance.
- The equipment which are used, are very simple and low of cost.
- This would be a best technique which can be adopted by the third world countries.

### REQUIREMENTS

- **HARDWARE REQUIREMENTS:**
  - Ultrasonic sensor
  - Arduino cable
  - Piezo buzzer
  - Jumper wires
  - Arduino uno board
  - 9v battery
- **SOFTWARE REQUIREMENTS:** The software used here is ARDUINO 1.6.7 version.

To overcome all these problems of blind people

PRINCIPAL  
Geethanjali College of Engg. Tech,  
Cheerl (V), Keesara (M), R.R. Dist. (A.P.) - 501 301

# Description of components

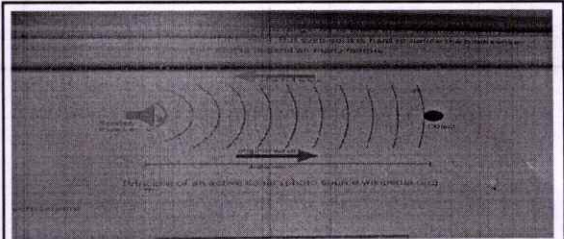

## SENSORS

- It is an object whose purpose is to detect events or changes in environment.
- The sensor used here is ultrasonic sensor.
- We use ultrasonic sensor because it detects small objects & large objects.

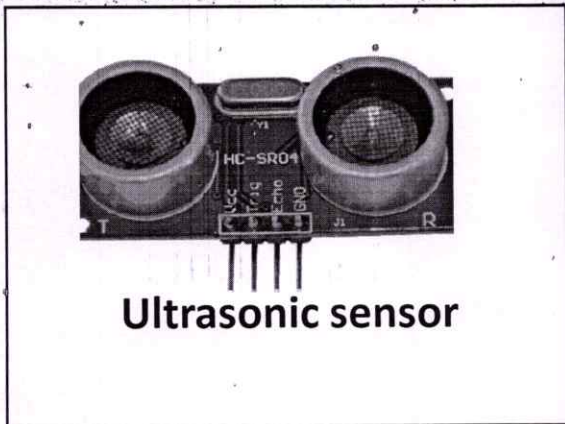

Ultrasonic sensor

## ARDUINO UNO

- Uno is a microcontroller board based on ATmega328P
- It has 14 digital input or output pins . where 6 analog inputs ,16 MHz quartz crystal ,a USB connection ,a power jack ,an ICSP header and a reset button.
- It contains everything needed to support microcontroller.

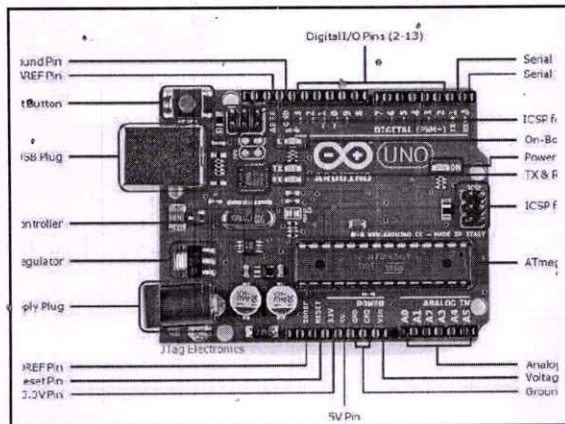

Other components

Geethanjali College of Engg. T  
 Cheeryal (V), Kaesara (M), R.R. Dist. (A.P.) - 501 302  
 PRINCIPAL  
 -1999- Tech.  
 Cheeryal (V), Kaesara (M), R.R. Dist. (A.P.) - 501 302



### WORKING

- The main component used is ULTRASONIC SENSOR.
- Sensor emits ultrasonic waves which are reflected back and are received by it.
- the reflected signals received from barrier objects are given as an input to MICROCONTROLLER(arduino uno).
- The microcontroller then used to determine the direction and distance of the object around visually impaired.

- MICROCONTROLLER also controls the peripheral components (buzzers) that alert the user about obstacle .
- This kind of work by microcontroller (arduino uno) is possible by giving the code for it through ARDUINO 1.6.7 version.
- We use 9v battery for power supply .
- Jumper wires for connections.
- Here we use piezo buzzer ,that receives signals from microcontroller through sensor acts as an indicator.

circuit diagram  
code  
test results  
will be done later.....

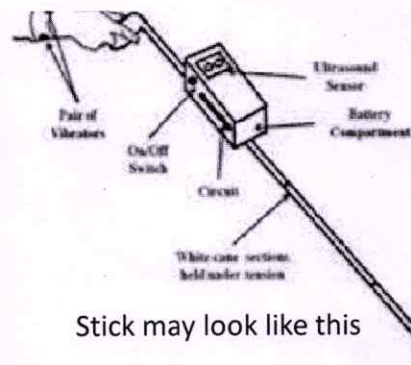

PRINCIPAL  
Geethanjali College of Engg. Tech.  
Cheeryal (V), Keesara (M), R.R. Dist. (A.P.) - 501 301

## Smart Switch

Team Members :

S.Piyush Balaji

Harshith

K.V.Nikhil

Shiva Kumar

## Smart Switch Problem Statement

- People this days turn on the lights and fans in the room and forget to switch off due to which there is a lot of wastage of electricity.



PRINCIPAL  
Geethanjali College of Engg. Tech.  
Chennai



## SOUND

Bharadwaj 15R11A0314  
Vishal 15R11A0343  
Tanmayi 15R11A05A5  
Sujana 15R11A0493  
Manikanta 15R11A04F2  
Varshã

### PROBLEM STATEMENT:

- The general ways of producing electricity is from renewable sources of energy like the thermal energy which may soon disappear. Production of thermal energy also causes lot of atmospheric pollution and damages the environment and results in the destruction of ozone layer. So we need some alternative sources to produce the energy. This could be done by the sounds around us.

  
PRINCIPAL  
Geethanjali College of Engg. Tech.  
Cheseryal (V), Keesara (M), R.R. Dist. (A.P.) - 501301

## BYCYCLE MOBILE CHARGER

Team: D.V.Varma (15R11A0315)

Venkat (15R11A0244)

Shreyas (15R11A05B8)

Hameed (14R11A04L5)

### PROBLEM STATEMENT

It is the most common problem faced by people in their day to day life. People travelling long distances would commonly face this issue.

"As a rule, the charging voltage with the engine at fast idle should usually be about 1-1/2 to 2 volts higher than battery voltage..An alternator failure will cause the battery to run down and go dead . Symptoms of charging problem include a low battery, dim headlights, hard starting or a charging system warning light."

PRINCIPAL  
Geethanjali College of Engg. Tech.  
Cheerla (V), Keesara (M), R.R. Dist. (A.P.) - 581 303



### CIRCUIT DIAGRAM

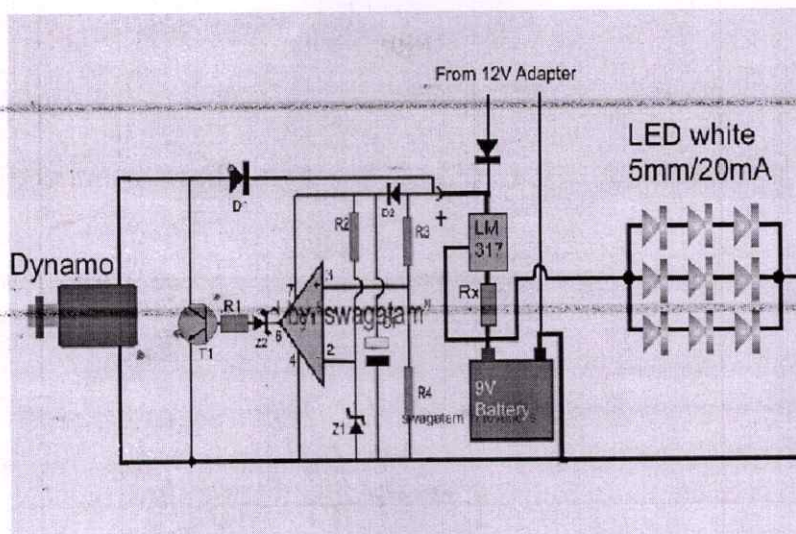

### COMPLETION REPORT

**Current status :**  
 we have fixed almost all the problems we faced ,around 70% for the project work is done and we are left over with assembling the entire parts of our project.

**PRINCIPAL**  
 Geethanjali College of Engg. Techno.  
 Theerth (V), Keesara (M), R.R. Dist. (A.P.)



# Energy Harvesting



- What is it?

- Macro scale- wind and solar



- Micro scale- electromagnetic and piezoelectricity

[3]

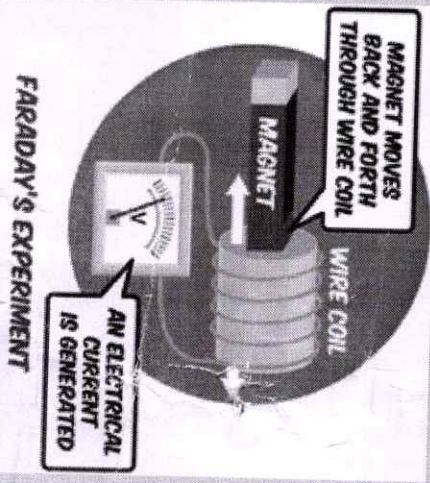

[2]

Geethanjali College of Engg. Techn.  
(Energy) Keesara (M), R.R. Dist. (S.P.)

PRINCIPAL



Attendance on 20/2/17

V. Anirudh	15VDIA0105	Civil-2A
L. Nikhil	15R11A0168	Civil-2B
M. Rajeev Reddy	15R11A0172	Civil-2B
P. Bhanu Kumar Reddy	15R11A0178	Civil-2B
K. Linga Raj	15R11A0120	Civil-2A
M. Rahul Sai	15R11A05E7	CSE-2C
V. Shiva Kumar	15R11A05H6	CSE-2C
N. SRIKANTH	15R11A0498	ECE-2b
D. Pagnu	15R11A04K3	ECE-2D
<del>B. Pr</del> V. Prashanth	15R11A04P8	ECE-2D
A. Shiva Sai	14R11A04J3	ECE-3D
Abhijeet Kumar	14R11A04J0	ECE-3D
Pranav Raju	14R11A04M6	ECE-3D
Hamed	14R11A04L5	ECE-3D
G. Anilkumar	15R11A05K8	CSE-2d
A. V. Ravi Kantsik	15R11A05J2	CSE-2D
S. V. Ayyappa Naik	15R11A05P3	CSE-2D
S. Kishore Kumar	15R11A05P0	CSE-2D
L. Martin David	15R11A04L8	ECE-2D
A. Chinmayi	15R11A04J1	ECE-2D
Jarhavi Deshmukh	15R11A04K1	ECE-2D
N. Pranay Teja	15R11A04M9	ECE-2D
P. Vichal Vinay	15R11A03U3	ME-2A
T. Srikanth	15R11A0352	ME-2A
K. V. NIKHIL	15R11A0485	ECE-2B

Geethanjali College of Engineering & Technology  
K. V. R. L. S. (A. P.) - 501 307



# Piezoelectric Energy Harvesting

**ITC**

**Veerendranath (ECE)**

**Jaya madhavi(ECE)**

**Santosh( MECHANICAL)**

**Sadiq Ali(mechanical)**

**PRINCIPAL**  
Geethanjali College of Engg. Tech.  
(Cheerla(V), Keesara (M), R.R. Dist. (A.P.) - 501 301)



# Piezoelectricity

- What is it?
- Occurs in polycrystalline materials
  - (For example: Quartz, lead-zirconate-titanate, Rochelle salt, etc.)



[4]



## Automatic Parking Slot Detection System

- T. Srikar
- Pranav Raju
- B. Kireeti

## Problem Statement

- Usually in the parking areas of malls and multiplexes, we need to look at the available slots by ourselves and if when the slot is occupied we have to go search for some other empty slot.

**PRINCIPAL**  
Geethanjali College of Engg. Tech.  
Chaeryal (V), Keesara (M), R.R. Dist. (A.P) - 501 302.



## Design for solution

- Components Needed
  - i. Ultrasonic Sensors
  - ii. PIR Sensors
  - iii. Cardboard
  - iv. Liquid Crystal Displays(16\*2)
  - v. Hot Glue
  - vi. Soldering Kit
  
- Circuit Diagrams / HW / SW Needed
  - I. Arduino Mega
  - II. Arduino IDE
- Flow diagram
- Any thing else relevant



PRINCIPAL  
Geethanjali College of Engg. Tech.  
Cheerayal (V), Keesara (M), R.R. Dist. (A.P.) - 501 301.

## Sensor Based Guide for Blind.

1. S. Nagalakshmi - 955012003 - sandhinagalakshmi@gmail.com - 15R11A05B0
2. J. Sai Venkata Tarun - 7989942594 - tarunjsv@gmail.com - 15R11A0479
3. Abhijeet Kumar - 8341000150 - abhijeetkumar179@gmail.com - 15R11A04J0
4. Ram Kanisik - 9515921458 - ramkanisik98@gmail.com - 15R11A05J2
5. M. Rahul Sai - 9515738043 - Rahulmallam98@gmail.com - 15R11A05E7

The project is aimed at helping visually challenged (Blind) people to move around normally ~~by~~ without using stick.

We are working on a design which is very small and can be strapped to person's shoes or one of the legs. This may help blind to walk like normal persons.



PRINCIPAL  
Geethanjali College of Engg. Tech.  
Cheerl (V), Keesara (M), R.R. Dist. (A.P.) - 501301.





## Power Generation Using Piezoelectric Material

Nayan HR\*

American International University, Dhaka, Bangladesh

### Abstract

In last few years low power electronic devices have been increased rapidly. The devices are used in a large number to comfort our daily lives. With the increase in energy consumption of these portable electronic devices, the concept of harvesting alternative renewable energy in human surroundings arise a new interest among us. In this project I try to develop a piezoelectric generator. That can produce energy from vibration and pressure available on some other term (like people walking ). This project describes the use of piezoelectric materials in order to harvest energy from people walking vibration for generating and accumulating the energy. This concept is also applicable to some large vibration sources which can find from nature. This project also represents a footstep of piezoelectric energy harvesting model which is cost effective and easy to implement.

**Keywords:** Piezoelectric sensor; Full-wave bridge rectifier; Lead acid battery; Load (LED and USB charger)

### Introduction

Now a day's energy is one of the most important issues around the world. Especially in Bangladesh energy crisis is a big problem. Renewable energy sources can be a great media to solve this energy crisis problem in Bangladesh. As we know natural resources will finish one day. That's why researchers are trying to introduce substitute energy sources from nature. That must be green and not harmful for the environment. Energy harvesting is defined as capturing minute amounts of energy from one or more of the surrounding energy sources. Human beings have already started to use energy harvesting technology in the form of windmill, geothermal and solar energy. The energy came from natural sources, termed as renewable energy. Renewable energy harvesting plants generate kW or MW level power; it is called macro energy harvesting technology. Moreover, micro energy also can produce from those natural sources that are called micro energy harvesting. Micro energy harvesting technology is based on mechanical vibration, mechanical stress and strain, thermal energy from furnace, heaters and friction sources, sun light or room light, human body, chemical or biological sources, which can generate mW or  $\mu$ W level power. Micro power supply needs is increasing greatly with time as our technology is moving to the micro and nanno fabrication levels. Our discussion on this is based on generating micro energy from vibration and pressure using piezoelectric material.

### Piezoelectric Sensor

This day most of the research in the energy field is to develop sources of energy for future. It is time to find renewable surceases of energy for the future. Piezoelectric materials are being more and more studied as they turn out to be very unusual materials with very specific and interesting properties. In fact, there materials have the ability to produce electrical energy from mechanical energy for example they can convert mechanical behavior like vibrations in to electricity. Such devices are commonly referred to as energy harvesters and can be used in applications where outside power is unavailable and batteries are not a feasible option. While recent experiments have shown that these materials could be used as power generators, the amount of energy produced is still very low, hence the necessity to optimize them.

Piezoelectric materials have two properties that are define as direct and converse effect. Direct effect is the property of some materials to develop electric change on their surface when mechanical stress is

erted on them ~~to develop~~ to develop mechanical stress when an electric charge is induced [1].

### Advantages:

1. Very high frequency response.
2. Self-generating, so no need of external source.
3. Simple to use as they have small dimensions and large measuring range.
4. Barium titanate and quartz can be made in any desired shape and form. It also has a large dielectric constant. The crystal axis is selectable by orienting the direction of orientation.

### Disadvantages

1. It is not suitable for measurement in static condition.
2. Since the device operates with the small electric charge, they need high impedance cable for electrical interface.
3. The output may vary according to the temperature variation of the crystal.
4. The relative humidity rises above 85% or falls below 35%, its output will be affected. If so, it has to be coated with wax or polymer material.

### Full-Wave Bridge Rectifier

Full-bridge rectifier is commonly used as rectifier circuits to convert the AC output of a piezoelectric into a DC voltage. The rectifying circuits consist of 4 diodes. The voltage needs to rectify due to the need for constant supply of voltage light up the series of LED placed in parallel [2].

\*Corresponding author: Nayan HR, American International University, Dhaka, Bangladesh, Tel: 880 2-8815386; E-mail: nayanhabib@yahoo.com

Received April 03, 2015; Accepted May 21, 2015; Published May 31, 2015

Citation: Nayan HR (2015) Power Generation Using Piezoelectric Material. J Material Sci Eng 4: 171. doi:10.4172/2169-0022.1000171

Copyright: © 2015 Nayan HR. This is an open-access article distributed under the terms of the Creative Commons Attribution License, which permits unrestricted use, distribution, and reproduction in any medium, provided the original author and source are credited.

Geethanjali College of Engineering & Technology  
Cheerayal (V), Keerasara (M), R.S. Dist. (W.D.) - 501 004



## Lead Acid Battery

Battery an array of electrochemical cells for electricity storage, either individually linked or individually linked and housed in a single unit. An electrical battery is a combination of one or more electrochemical cells, used to convert stored chemical energy into electrical energy. Battery standby power applications. Miniature cells are used to power devices such as hearing aids and wristwatches; larger batteries provide standby power for telephone exchanges or computer datacenters.

## Primary battery

Primary batteries can produce current immediately on assembly. Disposable batteries are intended to be used once and discarded. These are most commonly used in portable devices such as in alarm and communication circuits where other electric power is only intermittently available. Disposable primary cells cannot be reliably recharged, since the chemical reactions are not easily reversible and active materials may not return to their original forms. Battery manufacturers recommend against attempting recharging primary cells.

## Secondary battery

Secondary batteries assembled with active materials in the discharged state. Rechargeable batteries or secondary cells can be recharged by applying electrical current, which reverses the chemical reactions that occur during its use. Devices to supply the appropriate current are called chargers or rechargers [3,4].

## Loads

The USB charging converter convert 12V dc to 5V dc. It consist of IC-AD84064, capacitor, diode and LED. All of this component convert voltage to charge device like as Mobile, IPod, Tab, MP3 devices, and charger light etc. All the rechargeable equipment will be charged [5].

## Some common mistakes

Though piezoelectric material has the property of converting mechanical energy into electrical energy but developing piezoelectric generators is challenging because of their poor source characteristics (high voltage, low current, high impedance) and relatively low power output [6]. In the past these challenges have limited the development and application of piezoelectric generators. The main limitation of our project is I could not amplify the current or power from source to charge our battery faster with less steps. And another one is I could not find better piezoelectric sensor in our region. That's why I use buzzer as piezoelectric sensor, which has a little amount of piezo crystal material in its surface [7,8]. And the thickness of these sensors is much less. So these sensors could break by people pressure. But, finally I managed with our mechanical structure to give the strength and got maximum output as mW range (Figures 1-7).

## Result and finding

In 1 square ft. I used 12 piezo sensor.

As piezo sensors power generating varies with different steps, get

Minimum voltage=1 V per step

Maximum voltage=10.5 V per step

I took an average of 50 Kg weight pressure from single person.

Considering the steps of a 50 Kg weighted single person, the average calculation is:

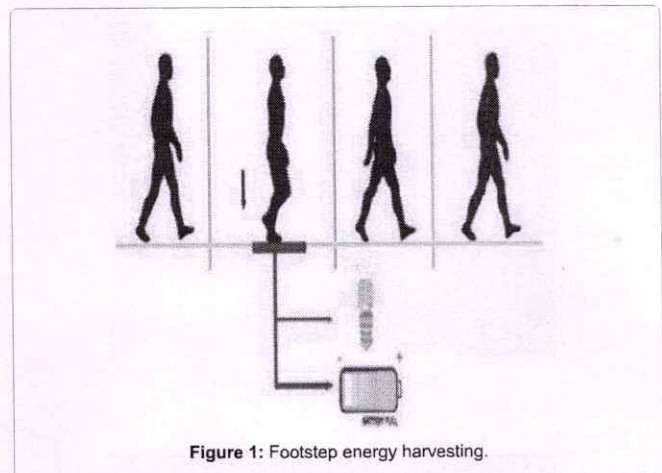

Figure 1: Footstep energy harvesting.

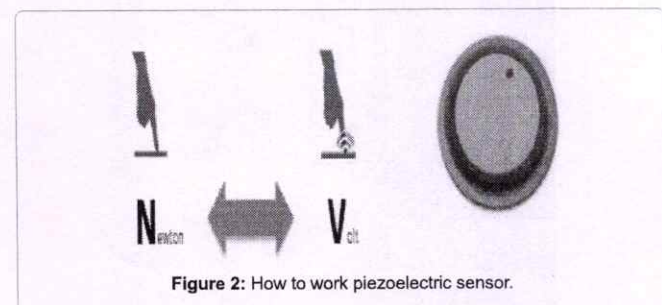

Figure 2: How to work piezoelectric sensor.

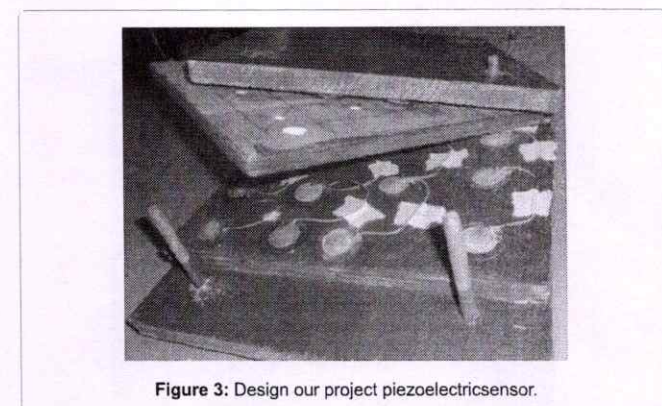

Figure 3: Design our project piezoelectricsensor.

It takes 800 steps to increase 1 V charge in battery.

So, to increase 12 V in battery total steps needed

$$=(12 \times 800)$$

$$=9600 \text{ steps}$$

As I will implement our project in a populated area where foot step as source will available, I took an average of 2 steps in 1 second.

For 9600 steps time needed

$$=9600/(60 \times 2)$$

$$=80 \text{ minutes. (Approximately)}$$



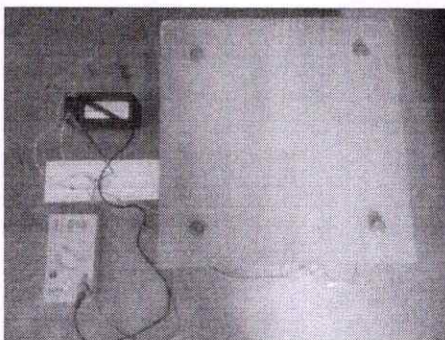

Figure 4: Charging model.

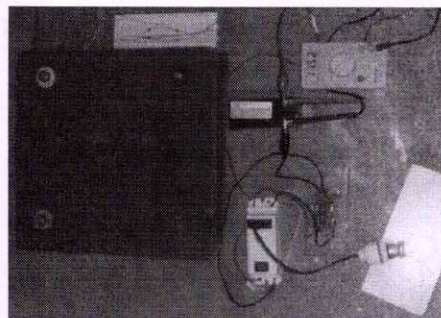

Figure 7: Connected a AC 5W bulb with inverter.

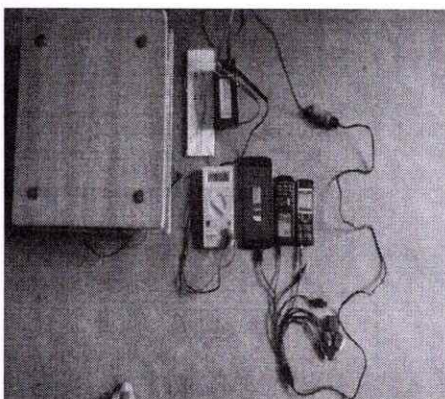

Figure 5: Connected allloads.



Figure 6: Connected a DC LED load.

are obviously some practical limitations to the systems presented. The final prototype design does fulfill the objective of generating electricity from piezoelectric disk. Due to the low cost design of the piezoelectric system it is a practical product which could increase the operating period of most common products. The data collected is capable of extending the operational lifespan per charge of portable electronic devices.

Although the theory developed in this report justifies the use of switching techniques in efficiently converting that energy to a usable form, there are obviously some practical limitations to the systems presented. Measurements of source current into the primary and load current transferred from the secondary reveal that very little current gain truly occurs between the input and output ports of the switch in the forward converter hybrid. Further, similar results were encountered when one examines the energy transferred through the series switch and inductor in the buck converter. In addition, based on the results gathered in this investigation, the final prototype design does fulfill the objective of generating electricity from piezoelectric disk. Due to the low cost design of the piezoelectric system it is a practical product which could increase the operating period of most common products. The data collected is capable of extending the operational lifespan per charge of portable electronic devices.

### Discussion

Bangladesh is a densely populated country. In Bangladesh, there are many regions where people are continuously travelling by walking. And these regions are always busy with people walking, which mean I can easily find the sources like vibration or pressure to produce electricity from piezoelectric material.

I created a mechanical structure for power generation. Inside that I placed a combination of many piezoelectric sensors. By pressing the structure the piezoelectric sensors will get the vibration and the sensors give electricity as output. After passing through a circuit the charge will store in the battery. I use two applications in our project. As I will place the model in a populated area, I can use this stored energy to light the passersby walking road without getting electricity from other sources. Another application is I can set a booth for charging mini power consumption devices which I use in our daily lives like mobile, iPod etc.

### References

1. What is Piezo and Piezoelectricity (2013).
2. Diodes bridge rectifier.jpg (2004)
3. Foot step power generation wood panel.jpg (2013)

### Conclusion

The project is successfully tested which is the best economical, affordable energy solution to common people. This can be used for many applications in city areas where want more power. Bangladesh is a developing country where energy management is a big challenge for huge population. By using this project. I can drive D.C loads according to the force I applied on the piezo electric sensor. Although the theory developed in this report justifies the use of switching techniques in efficiently converting that energy to a usable form, there

Geemania PRINCIPAL  
Geemania College of Engg. Tech.  
Dhaka, Bangladesh



# Automated Switch for High Beam Light

Team:

B.Thejesh (15R11A0312)

G.Bharath (15R11A05K5)

K J C Pavan Kumar(15R11A0482)

P.Grishma(15R11A05A0)

DVN RAMYA SAMHITHA(15R11A05K3)

Automated Switch for High Beam

Automated Switch for High Beam

PRINCIPAL  
Geethanjali College of Engg. Tech.  
Kazeroth (M), R.R. Dist. (A.P.) - 501 301



## Solution

The solution for this problem is a device which detects vehicle and human at a particular distance using RADAR or LASER and IR technology there by if sensor detects any, High beam is dipped to low beam and low beam continues to be in low it self

For RADAR or LASER

We would like to use Radar speed detectors or laser speed detector

For IR

We will use long range ir sensor

## Completion Report

Current status:- we are not completely have clear solution for this problem but we will soon find the solution and complete it

PRINCIPAL  
Geethanjali College of Engg. Techn.  
The Raj. P. S. Dist. (A. P.) - 501 301

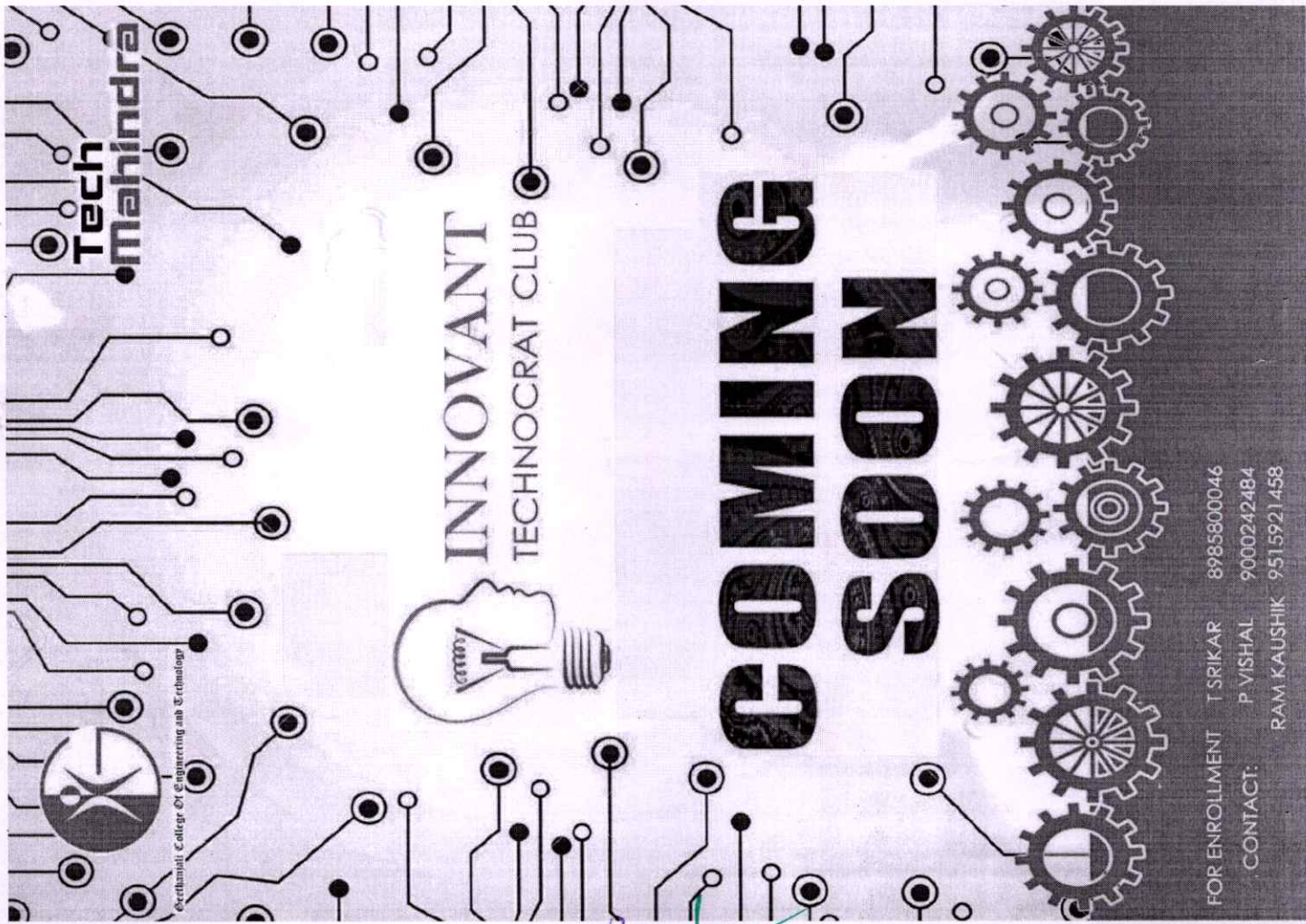

Tech Mahindra

INNOVANT  
TECHNOCRAT CLUB

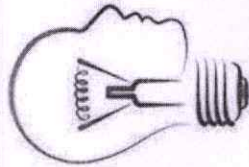

COMING  
SOON



FOR ENROLLMENT T. SRIKAR 8985800046  
CONTACT: P. VISHAL 9000242484  
RAM KAUSHIK 9515921458

PRINCIPAL  
Methanali College of Engg. Tech.



15R11A04N7 - ECE-2D

15R11A04R7 - ECE-2D

15R11A04K7

15R11A04M7 - "

15R11A04N8 - "

15R11A04N11 - "

15R11A0585 - CSC2B

5A0 - "

5B0 - "

472 - ECE-2B

479 - "

15R11A0315 - ME-2A

314 - "

312 - "

335 - "

341 - "

346 - "

349 - "

350 - "

343 - "

352 - "

15R11A0482 - ECE-2B

483 - "

498

15R11A0578 - CSC-2B

562 - "

571 -

588 -

PRINCIPAL  
Geethanjali College of Engg. Tech.  
Keesara (M. P. Dist. (A. P. 501 001)

S. Piyush Balaji

15R11A0248.

P. V. Venkatesai

15R11A0244

M. Sujana

15R11A0493

G. Vausha

15R11A0221

Aneeruddh

15R11A0257.

Nischala BN

15R11A0243

Deepika

15R11A05K1

Tanuja

15R11A05J5

Arulhya

15R11A0511

Sreekar

15R11A04L7

A. Raghav

PRINCIPAL  
Geethanjali College of Engg. Tech.  
15-01-2016 (A.P.)-501301



29. S. Nagalakshmi - 15R11A05B0.

30. G. Varsha - 15R11A0221

31. P. Tanmayi - 15R11A05A5

32. M. Sujana - 15R11A0493

33. S. Piyush Balaji - 15R11A0248

34. D. Veshnu Harshith - 15R11A0571

35. B. ShivaKumar - 15R11A05HC

Geethanjali College of Engineering & Technology  
Cheerpal (V), Keesara Taluk, West Godavari District - 501301  
PRINCIPAL

29. Sushanth 15R11A0349

3. am Kausik - 15R11A0552

4. G. Bharath - 15R11A05K5

5. S.V. Ayyappa Naik - 15R11A06P3

6. G. Anil Kumar - 15R11A05K8

7. G. Ajay Kumar - 15R11A0578

8. S. Kishore Kumar - 15R11A05P0

9. V. S. shreyas - 15R11A05B8

10. A.S. Bruhadroop 15R11A0562

11. D. Vishnu Harshith 15R11A0571

12. T. Srikar 15R11A0352

13. P. Vishal 15R11A0343

14. Pranav Raju 14R11A04M6

15. K.J.C. Pawan Kumar 15R11A0482

16. D.V. Varma 15R11A0315

17. Mohd. Hameed 14R11A04L5

18. Kireeti. B 14R11A04J6

19. Thejesh. B 15R11A0312

20. Sadiq Ali 15R11A0350

21. T. Raju 15R11A0353

22. Santosh 15R11A0341

23. Jaya Madhavi 15R11A0472

24. K.S. Veerendranath 15R11A0483

25. JSV Jarun 15R11A0479

26. Abhijeet Kumar 14R11A04J0

27. P. Grishma 15R11A05A0

28. M. Rahul Sai 15R11A05E7

29. N. Sankanth 15R11A0498

30. Venkat 15R11A0244



S.No	NAMES	CLASS/SEC	ROLL NO	PHONE NO	EMAIL ID
1	Pranav raju A	ECE-3D	14R11A04M6	9652139543	<a href="mailto:rajupranav96@gmail.com">rajupranav96@gmail.com</a>
2	Abhijeet kumar	ECE-3D	14R11A04J0	8341000150	<a href="mailto:abhijeetkumar179@gmail.com">abhijeetkumar179@gmail.com</a>
3	Surya priyanka	ECE-3D	14R11A0M1	9030002901	<a href="mailto:Nsuryapriyanka@gmail.co">Nsuryapriyanka@gmail.co</a>
4	Mohd hameed	ECE-3D	14R11A04L5	7801061380	<a href="mailto:Mohdsmphameed@gmail.com">Mohdsmphameed@gmail.com</a>
5	V.Shiva kumar	CSE-2C	15R11A05H6	8499849483	<a href="mailto:shivayadavvallala@gmail.com">shivayadavvallala@gmail.com</a>
6	Rahul mallam	CSE-2C	15R11A05E7	9515738043	<a href="mailto:rahulmallam98@gmail.com">rahulmallam98@gmail.com</a>
7	Y.Prudhvik	CSE-2C	15R11A05H9	7569545875	<a href="mailto:prudhvikkumar@gmail.com">prudhvikkumar@gmail.com</a>
8	Sushanth reddy	ME-2A	15R11A0349	7288855067	<a href="mailto:shawshankredemption6@gmail.com">shawshankredemption6@gmail.com</a>
9	Abhishek M	ME-2A	15R11A0335	9951581269	<a href="mailto:abhi20116@gmail.com">abhi20116@gmail.com</a>
10	M.rajeev reddy	CIV-2B	15R11A0172	9618184558	<a href="mailto:rajeevreddy161994@gmail.com">rajeevreddy161994@gmail.com</a>
11	L.Nikhil	CIV-2B	15R11A0168	8499834333	<a href="mailto:nikhilrocks84@gmail.com">nikhilrocks84@gmail.com</a>
12	P.Bhanu kumar reddy	CIV-2B	15R11A0178	9177876503	<a href="mailto:bhanureddy1166@gmail.com">bhanureddy1166@gmail.com</a>
13	G.Bharath	CSE-2D	15R11A05K5	9705280669	<a href="mailto:g.bharath1408@gmail.com">g.bharath1408@gmail.com</a>
14	S.V Ayappa naik	CSE-2D	15R11A05P3	9652155157	<a href="mailto:s.v.ayappanaik@gmail.com">s.v.ayappanaik@gmail.com</a>
15	A.V.R Kaushik	CSE-2D	15R11A05J2	9515421458	<a href="mailto:ramkaushik98@gmail.com">ramkaushik98@gmail.com</a>
16	S.Indira devi	ECE-2B	15R11A04A5	9966462189	<a href="mailto:sitaramindu@gmail.com">sitaramindu@gmail.com</a>
17	SVSN sruti	ECE-2B	15R11A04A9	9133471746	<a href="mailto:sishasruti@gmail.com">sishasruti@gmail.com</a>
18	Shanthan .K	ECE-2B	15R11A0491	7995542369	<a href="mailto:shanthan.kuchalakanti@gmail.com">shanthan.kuchalakanti@gmail.com</a>
19	Sujana M	ECE-2B	15R11A0493	9030819032	<a href="mailto:sujana.destiny@gmail.com">sujana.destiny@gmail.com</a>
20	Janhavi deshukh	ECE-2D	15R11A04K1	8142646188	<a href="mailto:jrdeshmukh528@gmail.com">jrdeshmukh528@gmail.com</a>
21	N.Pranay teja	ECE-2D	15R11A04M9	7330855787	<a href="mailto:pravinnys@gmail.com">pravinnys@gmail.com</a>
22	P.Tanmayi	CSE-2B	15R11A05A5	9618706487	<a href="mailto:tanmayi.pottabathini13@gmail.com">tanmayi.pottabathini13@gmail.com</a>
23	P.Grishma	CSE-2B	15R11A05A0	9705361971	<a href="mailto:grishmareddy@gmail.com">grishmareddy@gmail.com</a>
24	S.Naga lakshmi	CSE-2B	15R11A05B0	9550124003	<a href="mailto:sandirinalakshmi@gmail.com">sandirinalakshmi@gmail.com</a>
25	V.N.Tejaswi	CSE-2C	15R11A05H3	9948292634	<a href="mailto:veluritejaswi.17@gmail.com">veluritejaswi.17@gmail.com</a>
26	S.Sindhuja	CSE-2C	15R11A05G8	9000111346	<a href="mailto:sindhusandy44@gmail.com">sindhusandy44@gmail.com</a>
27	Harshitha. R	ECE-2D	15R11A04K7	998984921	<a href="mailto:harshu.rao2010@gmail.com">harshu.rao2010@gmail.com</a>
28	V.Sowmya	ECE-2D	15R11A04P7	9440666496	<a href="mailto:sowmya171997@gmail.com">sowmya171997@gmail.com</a>
29	R.Amulya	ECE-2D	15R11A04N7	7702950491	<a href="mailto:ravuriamulyajoyce17@gmail.com">ravuriamulyajoyce17@gmail.com</a>
30	A.Mounika	ECE-2D	15R11A04J2	9492638318	<a href="mailto:mounikakumari29@gmail.com">mounikakumari29@gmail.com</a>
31	V.Gayathri	ECE-2D	15R11A04M7	9014554417	<a href="mailto:vngayathri@gmail.com">vngayathri@gmail.com</a>
32	Samreen	ECE-2D	15R11A04N9	9908196373	<a href="mailto:samsamreen66@gmail.com">samsamreen66@gmail.com</a>
33	Farheen	ECE-2D	15R11A04P3	9542003466	
34	Anuhya	CSE-2A	15R11A0511	7382156760	<a href="mailto:anuhya227@gmail.com">anuhya227@gmail.com</a>
35	Deepika	CSE-2D	15R11A05K1	7416876031	<a href="mailto:deepikadhulipalla@gmail.com">deepikadhulipalla@gmail.com</a>
36	Tanuja	CSE-2D	15R11A05J5	8374325483	<a href="mailto:tanuja.ram8@gmail.com">tanuja.ram8@gmail.com</a>
37	S.Sowmya	ECE-2D	15R11A04N8	8686129070	<a href="mailto:sudarshansowmya07@gmail.com">sudarshansowmya07@gmail.com</a>

  
**PRINCIPAL**  
 Geethanjali College of Engg. Techn.  
 Cheeryal (Y), Kaesara (M), R.R. Dist. (A.P.) - 501 301



Announcements | Geeth: X  
www.gctportal.in/p/index.html

Question Papers  
Complaint Box

Reference Sites  
Geethanjali Institutions  
JNTU Hyderabad  
JNTU PORTAL

- 27/03:Internet of Things Hackathon Program at VBIT Details Available Here
- 22/03:Regular and Supplementary Notification for Autonomous Details Available Here
- 20/03:Hack your MVP of JNTU-Hyd on 21st March Details Available Here
- 16/03:Students Qualified for Final Round of Coding Competition Details Available Here
- Happy Holi
- 10/03:Pharm D I, II, III, IV & V Years & Pharm D(PB) II Year Regular Exam Notification Available Here
- 09/03:B.Tech B.Pharm II, III, IV Year II Sem Regular Supple Exam Notification Available Here
- 08/03:Postponement of B.Tech-B.Pharm- Suppy Exams March-2017 Details Available Here
- 08/03:Happy Women's Day 2017
- 07/03:Transportation Details from 8th - 20th March 2017 Details Available Here
- 05/03:Examination Centres for Supple Exams - March, 2017 Details Available Here
- 01/03:Drawyaka 2017 8th National Level Conference Details Available Here
- 25/02:B.Tech B.Pharm 2-1 3-1 4-1 Supple - March 2017 Time Table Details Available Here
- 23/02:JNTUH VI Convocation Notification Details Available Here
- 23/02:Shivratri Holiday Notification Available Here
- 20/02:V17 Coordinators and Volunteers Registration Form Available Here
- 18/02:Information about OD Notification by the request of 14, 15, 16 Pass outs Available Here
- 18/02:V17 Graphic and Web Designing Registration Form Available Here
- 16/02:Biometric Verification for Scholarship Students Details Available Here
- **14/02:ITC Notification for Meet on 15/02/2017 Details Available Here** *2nd Notification for Meetng.*
- 11/02:B.Tech I Year II Sem AR16 I MID Exam Time Table - Feb 2017 Available Here
- 10/02:B.Tech B.Pharm 2-1.3-1.4-1 Supple - Mar 2017 Exam Notification Available Here
- 10/02:Intake of Students into Official Deco Team on 11th Feb 2017 Details Available Here
- 08/02:Coding Competition by Dept. of CSE on 18th Feb 2017 Details Available Here
- **08/02:Innovant Technocrat Club Details Available Here** *1st Notification for nominations*
- 06/02:Oracle Academy Training Program Batch - 1 List Available Here

Read More >>

Geethanjali College of Engg. Tech.  
Cheruvu (V), Keesara (M), R.R. Dist. (A.P.) - 501 301

PRINCIPAL